



Adamson Systems Engineering

SPEKTRIX user manual

version 1.0

ADAMSON SYSTEMS ENGINEERING
TORONTO CANADA
T:+1 [905] 982 0520 F:+1 [905] 982 0609
www.adamsonsystems.com

Copyright © 2009 Adamson Systems Engineering Inc.

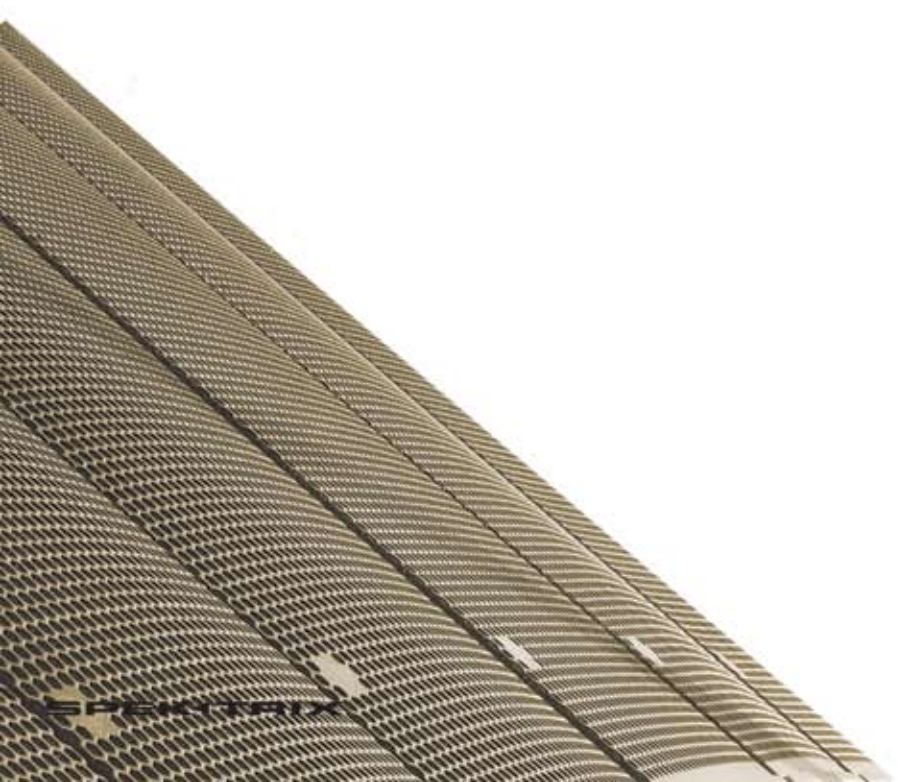

WARNING

This safety manual must be read by all that will operate the SpekTrix system, prior to use. The Adamson SpekTrix systems should not, under any circumstance, be operated by those who have not studied this manual. Supervision and competency are the responsibility of the system owners and operators. Owners and operators are responsible for inspecting the rigging and ensuring that it has not been damaged in transport, from misuse, or wear and tear. All welded intersections and joints, on the rigging frames, should be inspected regularly. Operators should not assume that the rigging has been inspected prior to use.

RIGGING

Correct use of all rigging hardware is required for safe use of this product. All rigging of this product must be done by a certified rigger. All users must read the SpekTrix User Manual and heed all warnings within, before use of this product.

SAFETY FACTOR

This product has an 8:10 Safety Factor. Any additional modules hung from this assembly will result in a reduction of the factor of safety of the lifting frame below that which is required.

LOUD NOISE

A qualified technician must be present during the installation and use of this product. This product is capable of producing extremely high sound pressure levels (SPL), and should be used according to specified local sound level regulations and good judgment. The SPL generated by this product may cause permanent hearing loss if used incorrectly.

MAINTENANCE

Before use of this product, all enclosure components including rigging must be thoroughly inspected for cracks, corrosion, deformation, or any other damage that could reduce the strength or safety of the array, by an expert trained and experienced in flying Adamson speaker systems.

PINCH FACTOR

This product and its rigging system has possible pinch points, all of which are shown in the User Manual. Make note of all possible pinch hazards before use.

DISCLAIMER

Adamson Systems Engineering will not be held liable for damages caused by any possible misuse of this product.



Warning

Read carefully before starting
p. 2

Section 1

- 1.1) Introduction to SpekTrix p.4
- 1.2) Product Line p. 4-5
- 1.3) What's inside the SpekTrix p. 6-7
- 1.4) Rigging Hardware p.8-11
- 1.5) Accessories p.12-14
- 1.6) Specifications:
 - SpekTrix p. 15-19
 - SpaekTrix W p. 20 -21
 - SpekTrix Sub p. 22-23

Section 2

- 2.0) Designing a project p. 24
- 2.1) Shooter Software p. 25
- 2.2) Shooter Quick Start Guide p. 26-31

Section 3

- 3.0) Total System Approach p. 32
- 3.1) Turnkey Solutions p. 33
- 3.2) Pin Configuration Table p. 34
- 3.3) Amp & Pin Configurations p. 35
- 3.4) Presets for Processors p. 36

Section 4

- 4.0) Rigging & Cabling Instructions p. 37
- 4.1) Precautions p. 37
- 4.2) Flying the Array p. 38-45
- 4.3) Ground Stacking the Array p. 46
- 4.4) Rigging Certificate p. 47

Section 5

- 5.0) Configuration Examples p. 48-71



1.1 Introduction

This manual is designed to help SpekTrix users to correctly rig and understand the principles & versatility behind the SpekTrix True Line Source Array. The Adamson SpekTrix Series offers all the benefits of a true line-source array via patented wave shaping sound chamber technology.

1.2 Product Line

SPEKTRIX

Product Code:
900042



Description:

SpekTrix is a three-way cabinet that exhibits extremely high output for a compact box. The enclosure incorporates two unique Adamson 8.5" Kevlar, neodymium drivers - one ND8-L midbass driver and one ND8-M mid-range driver, and one B&C DE 900 compression driver mounted on a patented Adamson wave shaping sound chamber. The sound chamber has a defined coverage pattern of 5-degrees V by 120-degrees H, and is similar to the inner body of a Y-Axis drive module, giving the SpekTrix a slightly curved, iso-phase wave front comparable to that of the Y-Axis system.

SPEKTRIX W

Product Code:
900041



Description:

The 15-degree trapezoidal cabinet design makes it easy to achieve extreme downward angles at the bottom of an array, ensuring optimal coverage in the front rows and is perfect for use in wide vertical coverage array designs. Both SpekTrix and SpekTrix W are 3-way enclosures.

1.2 Product Line



SPEKTRIX **SUB**

Product Code:
900043



Description:

the SpekTrix Sub is the first Adamson enclosure to introduce Convertible Cardioid Technology, and is a single-sided box that can be arrayed conventionally (all facing the same way) or can be arrayed in back-to-front pairs for true cardioid performance.

The SpekTrix Sub is equipped with two powerful AW18 Kevlar LF drivers mounted in a tuned, vented and fully braced cabinet.





1.3 What's Inside the SpekTrix?

SpekTrix W's components are exactly the same as the SpekTrix Enclosure's, except for its HF sound chamber, which is distinct in order to attain its 15 degrees of vertical coverage.



The SpekTrix Sub features Two Adamson AW18 LF Drivers, which are manifold loaded.

Product Code:
8600004

1.3 What's Inside the SpekTrix?



The Adamson ND8-L

Product Code:
861021



The Adamson ND8-M

Product Code:
861020



The Adamson SpekTrix HF Sound Chamber

Product Code:
743110 SpekTrix, 743120 SpekTrix W



SpekTrix HF Driver B&C DE900

Product Code:
860057



1.4 Rigging Hardware



The SpekTrix Series features AIR™ system revolving disk flying hardware that is recessed, attached and hidden inside the box when arrayed. Precise angular positioning of the SpekTrix is controlled by the rotating wheel, selecting the rigging angle on the revolving disk changes rear enclosure spacing, while the trapezoidal shape of the enclosure ensures that there are no gaps in the front of the array.

The AIR™ Revolving Disk clearly indicated 6 precise rigging angles on a Logarithmic scale.

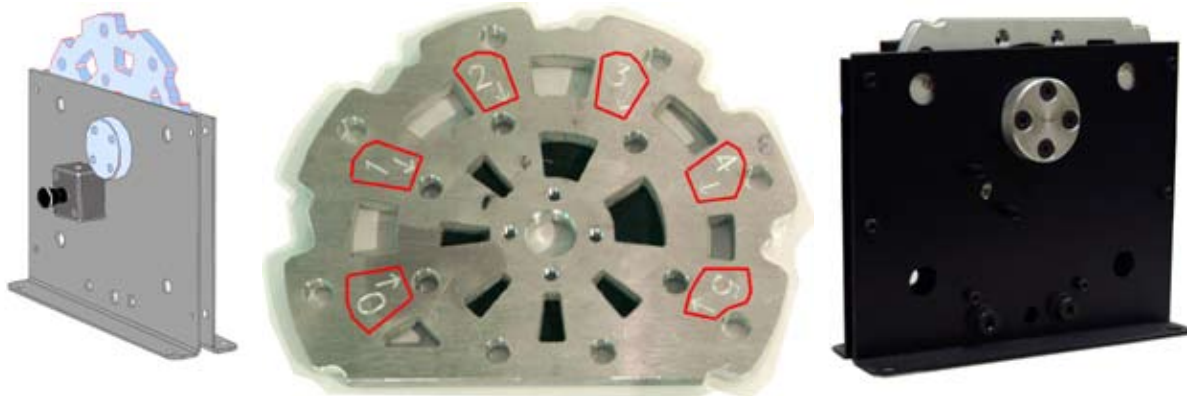

Product Code: 884145 SpekTrix Rigging Wheel
884147 SpekTrix W Rigging Wheel

The SpekTrix Push Pin



The Push Pin is used to secure the rigging frame to the SpekTrix boxes (one each side) as well as connecting subwoofer enclosures. Stacking plates are attached to rigging frame using push pins.

The SpekTrix Line only uses one size push pins.

Product Code:
881122

1.4 Rigging Hardware

SpekTrix Rigging Frame
Product Code:
Aluminum: 920042
Steel: 920056



Rigging Frame Assembly:
One Lightweight Aluminium or Steel Frame
Push Pins x 4
SpekTrix Stacking Plates for SpekTrix x 2
and Optional Extended Stacking Plates for SpekTrix W x 2

The SpekTrix Lifting Frame forms the basis for the SpekTrix array and is capable of holding up to 16 SpekTrix enclosures. The SpekTrix rigging frame is equipped with a single threaded moving pick point, enabling the center of balance and tilt angle to be precisely adjusted.

Additional lifting frame components can be removed from the frame to allow for easy packing and transport. Two lifting frames may be transported with right (top) sides facing, so that the threaded pick point rests within the channel of the other frame to create a flat pack. Adamson Also offers a compact SpekTrix rigging flightcase, which neatly holds 2 Frames and has 2 drawers for additional accessories such as motor etc.

IMPORTANT: Carefully inspect the lifting frame and brackets prior to every use to ensure there are no cracks, corrosion or deformity that could compromise the safety of an array. Using a damaged frame could result in mishap or serious injury.

1.4 Rigging Hardware

Stacking Plates and Extended Stacking Plates

Product Code:

880146 SpekTrix Stacking Plates

883038 SpekTrix W Extended Stacking Plates

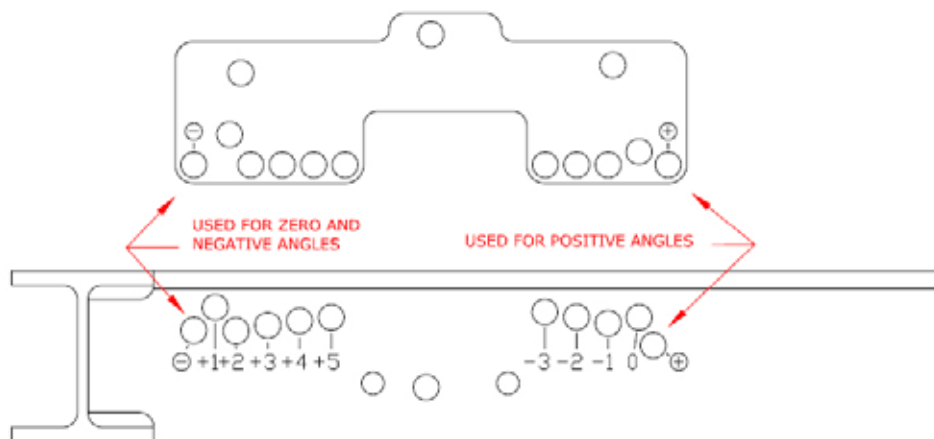

Ground Stacking Plates are used for ground stacking the SpekTrix cabinet, one attached to each side of the rigging frame. The Ground Stack Adapter Plates facilitate both positive and negative angle ground stacking. The plates feature a series of holes which are marked with the corresponding angle. These are only used in ground stacking applications.

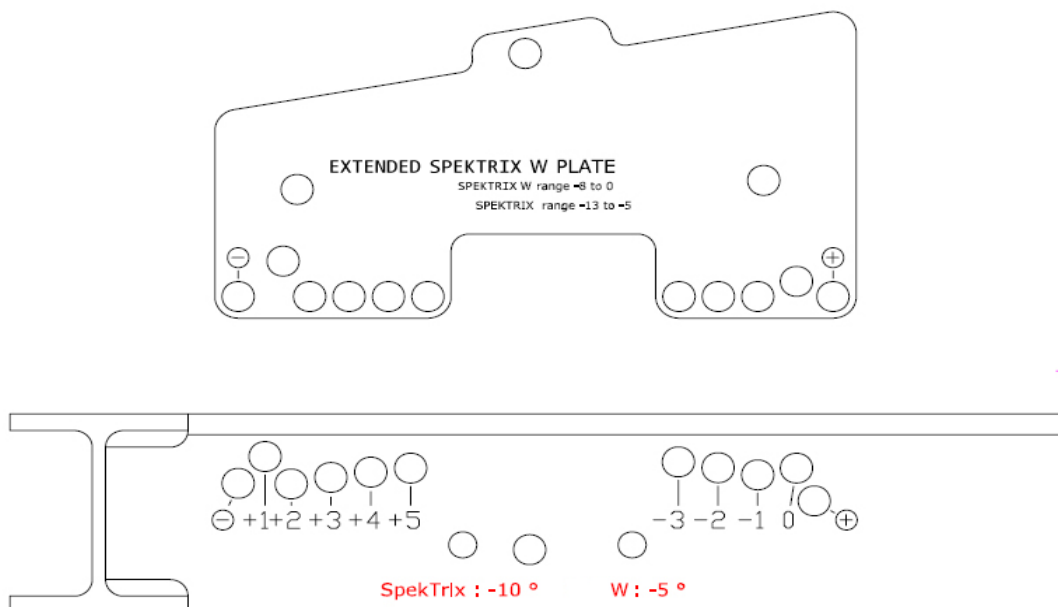

1.4 Rigging Hardware

Underhang Kits

Y10 / SpekTrix
Product Code: 920204



Please refer to the "Y-Axis User Manual" for instructions on the use of Adamson Underhang Kits.

Y18 / SpekTrix
Product Code: 920203



Y18 Flown with SpekTrix using Adamson Underhang kit.



1.5 Accessories

Dolly Boards

1. SpekTrix 4-stack/ 3 SpekTrix with 1 SpekTrix W
2. SpekTrix Subs x 2

Product Code:

970178 SpekTrix & SpekTrix W Dolly

970179 SpekTrix Sub Dolly

The dolly for a SpekTrix - 4 stack is configured so that the captive rigging point and angle, support the enclosure.

Dollies are included in every SpekTrix purchase.

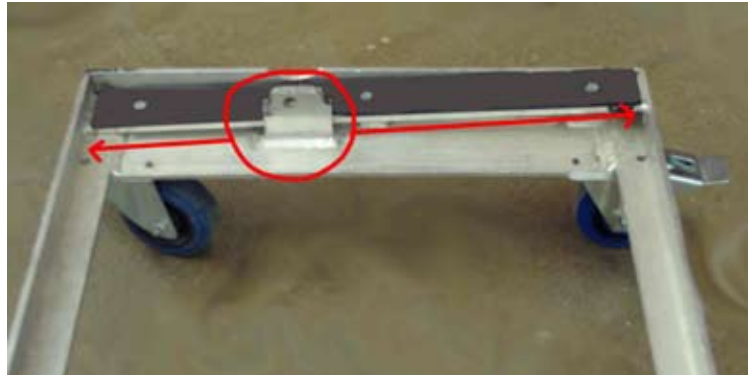

1.5 Accessories

Flight Case

Product Code: 890148

Description:

Flightcases are configured the same way as Dolly Boards.

3 SpekTrix or 3 SpekTrix with one SpekTrix W enclosure per case. There are no flightcases available SpekTrx Subs.



Soft Covers for SpekTrix Sub

Product Code: 891043

Description:

SpekTrix Sub soft covers are custom made with padded waterproof Cordura. They are designed to be used with a 2 SpekTrix Sub stack. The top includes a pocket designed to take a plywood square, which can be added in order to truckpack additional cabinets on top of the SpekTrix Subs when needed. This will protect the SpekTrix Sub's spring loaded AIR Rigging hardware when in transit. All SpekTrix Sub covers are screen printed with the Adamson Logo and product name.



1.5 Accesories

Cabling PART #'s



- NL8-3' #940054 male-male (picture 2)
- NL8-10' #940055 male-male
- NL8-25' #940056 male-male
- NL8-50' #940057 male-male
- NL8-100' #940058 male-male

- Soca 50' #900531 19 pin 12 AWG
- Soca 100' #900530 19 pin 13 AWG
- Soca150' #900529 19 pin 13 AWG
- Soca Splay #900532 19 pin soca to 2 x NL8 (picture 1 & 3)
- Soca Splay Sub #900533 19 pin soca to 4 x NL8 (picture 1)



Adamson Inclinometer Set #940001

The measuring kit includes a digital inclinometer set and a tape measure safely secured in a die-cut foam/durable plastic casing. The sensor is fitted to the rigging frame or placed onto a cabinet which allows the measuring of the aiming angle.

The sensor is connected to the display with a standard XLR3 cable (picture 4) for remote access. When switching the inclinometer on, the laser beam is automatically activated, facilitating not only the visual control of the array's vertical aim but the horizontal positioning as well.

The tape measure included in the kit is used to measure the trim height of the array, in order to match it with your Shooter® simulation.

Two separate batteries enable the use of the inclinometer, even if the laser battery is low.

The sensor is fastened to the rigging frame with a steel safety rope.



product specifications



SPEKTRIX

- FULL RANGE 3-WAY CABINET
- TRUE LINE SOURCE ARRAY
- ADAMSON WAVE SHAPING SOUND CHAMBER
- AIR™ SYSTEM REVOLVING DISK RIGGING
- COMPACT & LIGHTWEIGHT



The compact SpekTrix offers all the benefits of a True line Source via patented wave shaping sound chamber technology (US Patent # 6,581,719) The SpekTrix wave shaping sound chamber produces a slightly curved wave front in the HF that is comparable to the wavefront found in the Y-Axis. The 5 degree Vertical coverage, 3 Way SpekTrix Enclosure exhibits extremely high output for it's compact size.

Designed for optimal ease-of-use, smaller sound companies will also appreciate the cabinet's affordability, light weight and compact size. The AIR™ (Adamson Integrated Rigging) system revolving disk flying hardware makes setting up an entire array so easy, it can be accomplished by one person. There's no extra rigging hardware to misplace - everything is attached and recessed inside the enclosure.

When arrayed, AIR™ flying hardware is concealed, giving the system a modest, sleek look that makes it well suited for installation in small to medium-sized venues, theaters and houses of worship.

technical specifications



SPEKTRIX

FEATURES

The Adamson SpekTrix is a three-way cabinet that exhibits extremely high output for a compact box. The enclosure incorporates two unique Adamson 8.5" Kevlar, neodymium drivers - one ND8-L mid-bass driver and one ND8-M mid-range driver, and one B&C DE 900 compression driver mounted on a patented Adamson wave shaping sound chamber.

The sound chamber has a defined coverage pattern of 5-degrees V by 120-degrees H, and is similar to the inner body of a Y-Axis drive module, giving the SpekTrix a slightly curved, iso-phase wave front comparable to that of the Y-Axis system.

The SpekTrix features AIR™ system revolving disk flying hardware that is recessed, attached and hidden inside the box when arrayed, making the cabinets perfect for industrial applications where you want a system to look discreet. A single person can easily set up an entire array.

The SpekTrix rigging frame is equipped with a single threaded moving pick point, so the center of balance and tilt angle can be precisely adjusted with little effort.

The sleek, trapezoidal SpekTrix cabinet weighs only 62 lbs, and is constructed from rugged 5/8" Baltic birch with a dual component black speckle coat finish. All SpekTrix cabinets are supplied with lightweight, rugged aluminum dolly boards (four cabinets per dolly), with flight cases available upon request.



Specifications are subject to change without notice.

PHYSICAL DATA

Dimensions & Weight

Height (cm)	8.6" (22)
Width (cm)	27.9" (71)
Depth (cm)	18.91" (48)
Weight (Kg)	62lb (29.03)

Shape	5 degree trapezoid
-------	--------------------

Box Finish	Waterborne Acrylic
Hardware Finish	Water Based Bake Enamel

Optional Accessories	Aluminum Rigging Frame
----------------------	------------------------

Rigging	AIR™ Revolving Disk Rigging with 6 precise rigging angles on a logarithmic scale
---------	--

Protective grille	16 Gauge cold steel
-------------------	---------------------

Cabinet Construction	Rugged 11 ply Baltic Birch
----------------------	----------------------------

TECHNICAL DATA

Frequency Response	(+/-3dB)
Full Range Preset	80 Hz to 18 KHz
With Sub	35 Hz To 18 kHz

Frequency Range	
with Xover Preset	110 Hz – 18 kHz

Maximum SPL (Continuous / Peak)	
with Xover Preset	130.1dB / 136.1dB
with Full Range Preset	129.8dB / 135.8dB

Directivity	
Horizontal	120 degrees
Vertical (per element)	5 degrees

Sensitivity (2.83V @ 1m)	
LF	94.5dB / 80 Hz – 250 Hz
MF	99dB / 250 Hz – 900 Hz
HF	112dB / 900 Hz – 18 kHz

LF Section (Impedance ohms)	ND8-L 8.5" Kevlar neodymium Mid-Bass driver (8ohms)
-----------------------------	---

MF Section (Impedance ohms)	ND8-M 8.5" Kevlar neodymium Mid-Range driver (8ohms)
-----------------------------	--

HF Section (Impedance ohms)	B&C DE 900 1.5" compres. driver (8 ohms)
-----------------------------	--

Power Handling (AES Program / Peak)	
LF	250 / 500 / 1000
MF	250 / 500 / 1000
HF	80 / 160 / 320

Connection	Neutrik Speakon™ NL8
------------	----------------------

SPEKTRIX
SERIES

directivity diagrams



SPEKTRIX

Polar plots 100 - 250 Hz ; 6 dB/div

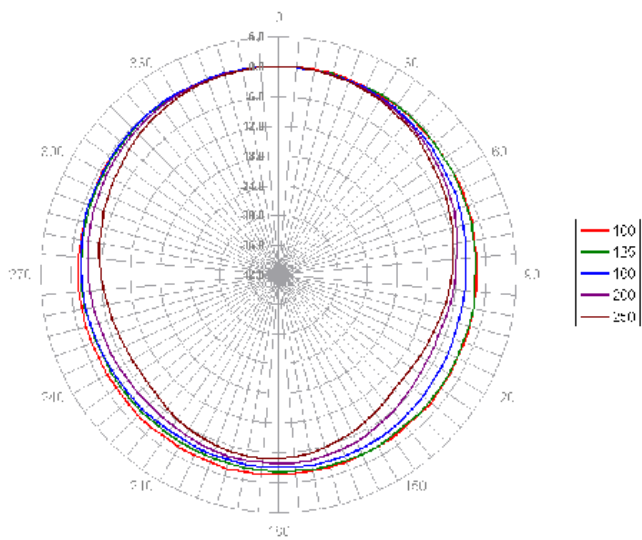

Polar plots 315 - 630 Hz ; 6 dB/div

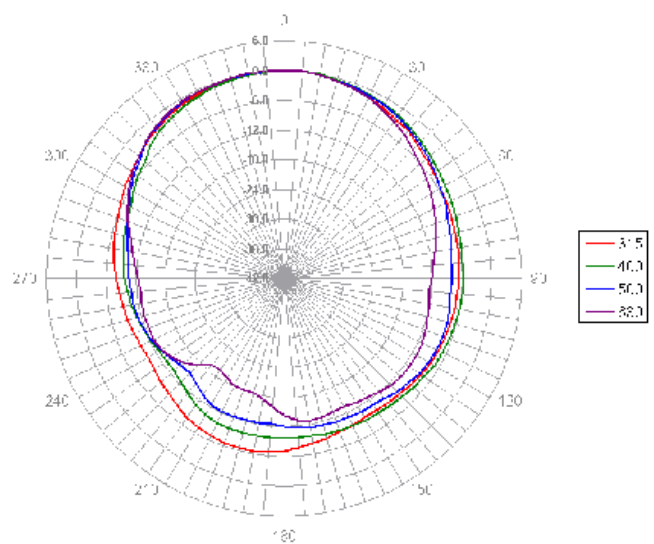

Polar plots 800 Hz - 1K6 ; 6 dB/div

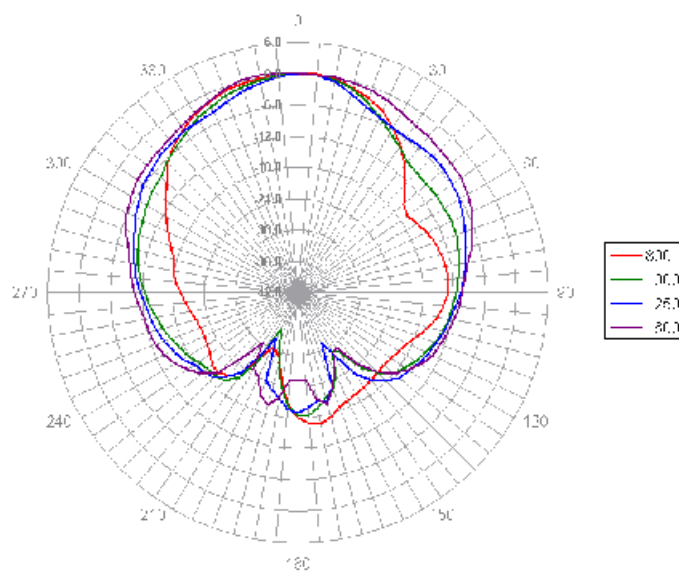

SPEKTRIX
SERIES

directivity diagrams



SPEKTRIX

Polar plots 2K - 4K ; 6 dB/div

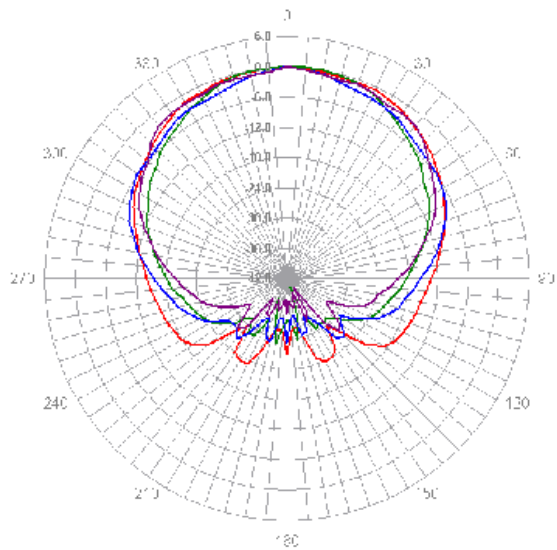

Polar plots 5K - 10K ; 6 dB/div

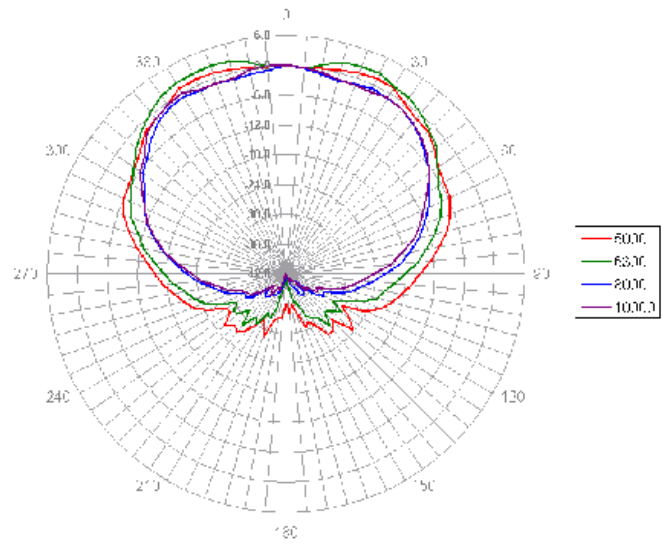

Polar plots 12K5 - 20K ; 6 dB/div

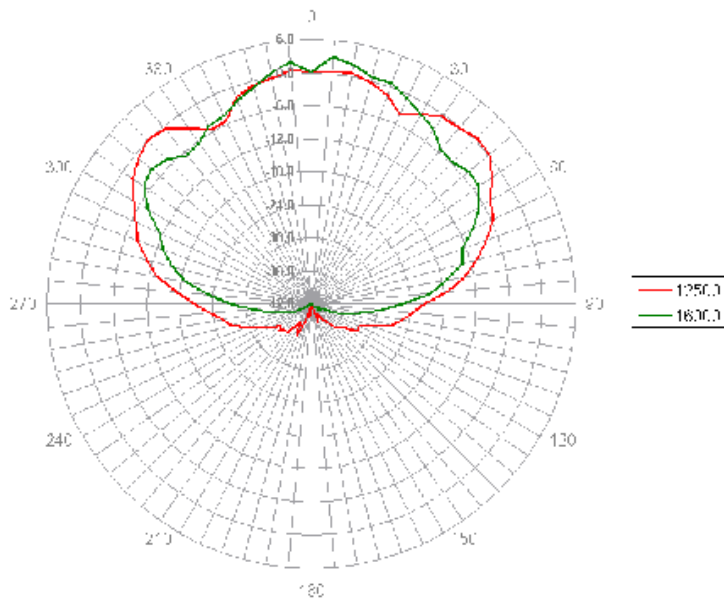

SPEKTRIX
SERIES

directivity diagrams



SPEKTRIX

-3dB & -6dB Isobar

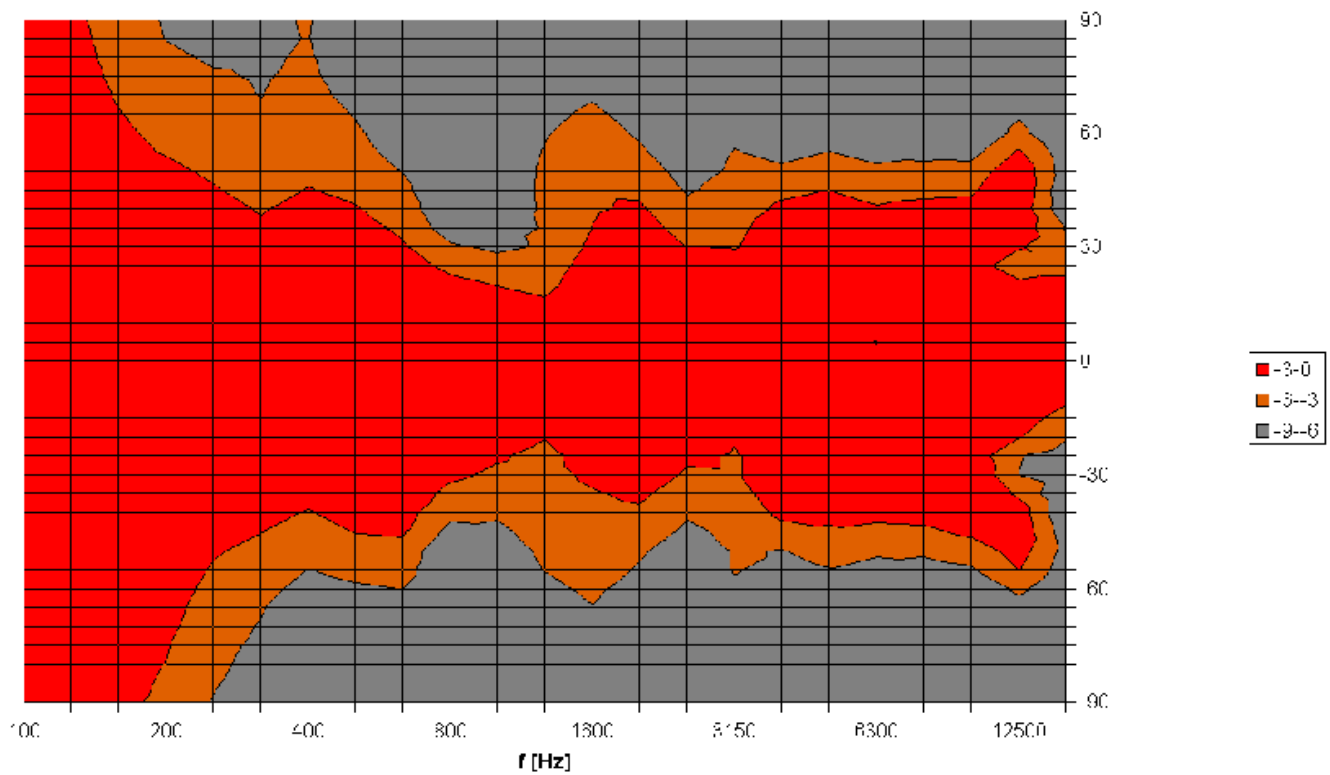

Single enclosure measurement.
Low frequency directivity increases as more enclosures are added (as the length of the array increases).

product specifications



SPEKTRIX **W**

- FULL 3-WAY CABINET
- TRUE LINE-SOURCE
- AIR™ SYSTEM PRECISION FLYING HARDWARE
- ADAMSON WAVE SHAPING SOUND CHAMBER
- COMPACT & LIGHTWEIGHT



The SpekTrix W brings a new element of versatility to the SpekTrix compact line array series, while offering all the benefits of line-source technology via its patented Adamson wave shaping sound chamber.

The 15-degree trapezoidal cabinet design makes it easy to achieve extreme downward angles at the bottom of an array - ensuring optimal coverage in the front rows - and is perfect for use in wide vertical coverage array designs (for instance, in theaters with multiple balconies).

The compact SpekTrix W offers all the benefits of a True line Source via patented wave shaping sound chamber technology (US Patent # 6,581,719) The SpekTrix wave shaping sound chamber produces a slightly curved wave front in the HF, that is comparable to the wavefront found in the Y-Axis.

The SpekTrix W incorporates the revolutionary AIR™ (Adamson Integrated Rigging) system and offers three precise rigging angles on a revolving disk. Suitable for touring applications, various fill requirements and installation in small- to medium-sized clubs, theatres and houses of worship, the SpekTrix W raises the bar and delivers the full features and flexibility you need in a compact system.

Product Code 900041

SPEKTRIX
SERIES

technical specifications

SPEKTRIX W



FEATURES

The Adamson SpekTrix W is a three-way cabinet that exhibits extremely high output for a compact box.

The 15-degree trapezoidal enclosure incorporates two unique Adamson 8.5" Kevlar, neodymium drivers - one ND8-L mid-bass driver and one ND8-M mid-range driver, and one B&C DE 900 compression driver mounted on a patented Adamson wave shaping sound chamber.

The sound chamber produces a slightly curved, iso-phase wave front, and has a defined coverage pattern of 15-degrees Vertical by 120-degrees Horizontal.

The sleek, trapezoidal SpekTrix cabinet weighs only 64 lbs, and is constructed from rugged 5/8" Baltic birch with a waterborne acrylic finish.



PHYSICAL DATA

Dimensions & Weight	
Height (cm)	10.4" (26.4)
Width (cm)	27.9" (71)
Depth (cm)	18.91" (48)
Weight (Kg)	64lb (29.03)
Shape	15 degree trapezoid
Box Finish	Waterborne Acrylic
Hardware Finish	Water Based Bake Enamel
Optional Accessories	Aluminum Rigging Frame
Rigging	AIR™ Revolving Disk Rigging with 3 precise rigging angles
Protective grille	16 Gauge cold steel
Cabinet Construction	Rugged 11 ply Baltic Birch

TECHNICAL DATA

Frequency Response	(+/-3dB)
Full Range Preset	80 Hz to 18 KHz
With Sub	35 Hz To 18 kHz
Frequency Range	
with Xover Preset	110 Hz – 18 kHz
Maximum SPL (Continuous / Peak)	
with Xover Preset	130.1 dB / 136.1 dB
with Full Range Preset	129.8dB / 135.8dB
Directivity	
Horizontal	120 degrees
Vertical (per element)	15 degrees
Sensitivity (2.83V @ 1m)	
LF	94.5dB / 80 Hz – 250 Hz
MF	99dB / 250 Hz – 900 Hz
HF	112dB / 900 Hz – 18 kHz
LF Section (Impedance ohms)	ND8-L 8.5" Kevlar neodymium Mid-Bass driver (8ohms)
MF Section (Impedance ohms)	ND8-M 8.5" Kevlar neodymium Mid-Range driver (8ohms)
HF Section (Impedance ohms)	B&C DE 900 1.5" compr. driver (8 ohms)
Power Handling (AES Program / Peak)	
LF	250 / 500 / 1000
MF	205 / 500 / 1000
HF	80 / 160 / 320
Connection	Neutrik Speakon™ NL8

Specifications are subject to change without notice.

SPEKTRIX
SERIES

product specifications



SPEKTRIX **SUB**

- HIGH SOUND PRESSURE LEVELS
- CONVENTIONAL or TRUE CARDIOID PERFORMANCE
- ENCLOSURE DESIGNED FOR MAXIMUM EFFICIENCY
- FREQUENCY RESPONSE OF 40 - 160Hz
- AIR™ SYSTEM FLYING HARDWARE



Designed as a companion to our SpekTrix compact line array cabinet, the SpekTrix Sub was the first Adamson enclosure to introduce Convertible Cardioid Technology, and is a single-sided box that can be arrayed conventionally (all facing the same way) or can be arrayed in back-to-front pairs for true cardioid performance.

The SpekTrix Sub is equipped with two powerful AW18 Kevlar bass drivers mounted in a tuned, vented and fully braced cabinet. The precision-machined, spring-loaded rigging hardware recesses into the cabinet when not in use and works in conjunction with other AIR™ system rigging elements to allow for a variety of configurations - attach the subs to the rigging frame and hang the SpekTrix underneath them, or stack your subs directly on the floor and ground stack your array on top.

The SpekTrix Sub loads in pairs on an aluminum dolly board and has been designed to ensure an easy truck pack.

technical specifications

SPEKTRIX SUB



FEATURES

A compact, sub-bass loudspeaker designed to provide high SPL extended bass to Adamson SpekTrix enclosures, the SpekTrix Sub is equipped with two powerful AW18 18" Kevlar low frequency drivers in a tuned, vented enclosure.

The cabinet is fully braced to minimize LF resonance and maximize efficiency. Four sets of captured, precision-machined aluminum rigging hardware are spring-loaded and retract into the cabinet body when not in use; and four NL8 connectors (two front, two back) enable easy cable loop-thru regardless of the sub's orientation.

- Dual AW18 18" Kevlar Bass drivers
- Frequency Response of 40 - 160 Hz
- Efficient Cabinet Design
- Durable, Waterborne Acrylic Finish
- Captured, Spring-Loaded Precision Rigging Hardware
- Easy Truck Pack with 2 cabinets per dolly paired with optional waterproof softcovers for protection

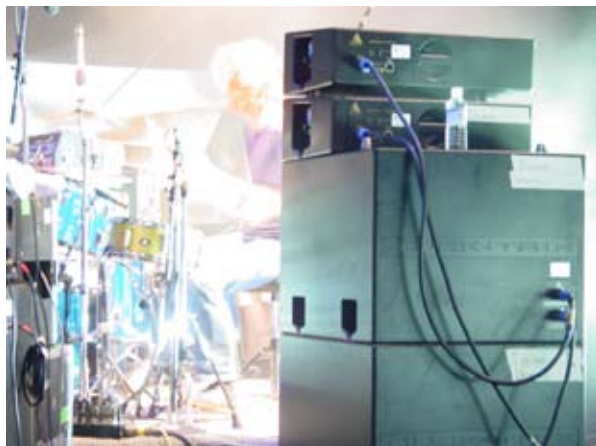

Specifications are subject to change without notice.

PHYSICAL DATA

Dimensions & Weight

Height (cm)	23" (58.5)
Width (cm)	28" (64)
Depth (cm)	32" (84)
Weight (Kg)	170lb (77)

Shape	Rectangular
Box Finish	Waterborne Acrylic
Hardware Finish	Back Bake Enamel
Flying Points	Captured spring-loaded precision machined aluminum
Protective grille	14 Gauge cold steel
Cabinet Construction	Rugged 15-ply Baltic Birch, internally braced
Accessories	Aluminum Dolly Board
Optional Accessories	Aluminum or Steel Rigging Frame, Waterproof Soft cover

TECHNICAL DATA

Frequency Response (+/-3dB)

Full Range Preset	40Hz - 160Hz
-------------------	--------------

Frequency Range

Xover Preset	35 Hz - 110 Hz
--------------	----------------

Maximum SPL (Continuous)

132dB

Directivity

Convertible to Cardioid

LF Section

Two Adamson AW18 18" Kevlar Low Frequency Drivers

Power Handling (AES / Program / Peak)

LF 600 / 1200 / 2400

Nominal Impedance

4 ohms

Sensitivity (2.83V @ 1m)

105.8dB

Connection

Neutrik Speakon™ NL8 (2 front, 2 rear)

2.0 Designing a Project

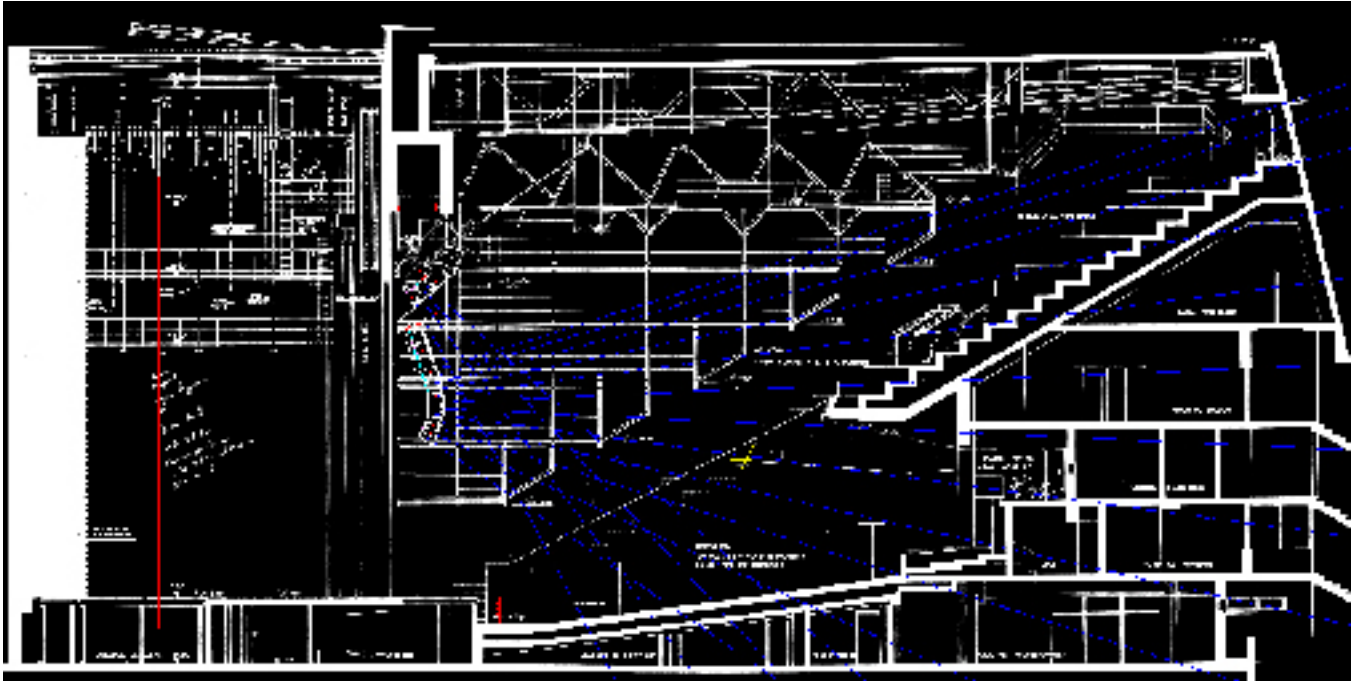

2.1 Shooter Software

Shooter

Adamson Shooter Software is available by request only. It's free for all Y-Axis, SpekTrix and Metrix partners, designers and end-users. Please call Adamson Systems Engineering 905-982-0520 to request the FTP download information, or website link password for the most current version available.

http://www.adamsonproaudio.com/technical_support/get_adamson_shooter

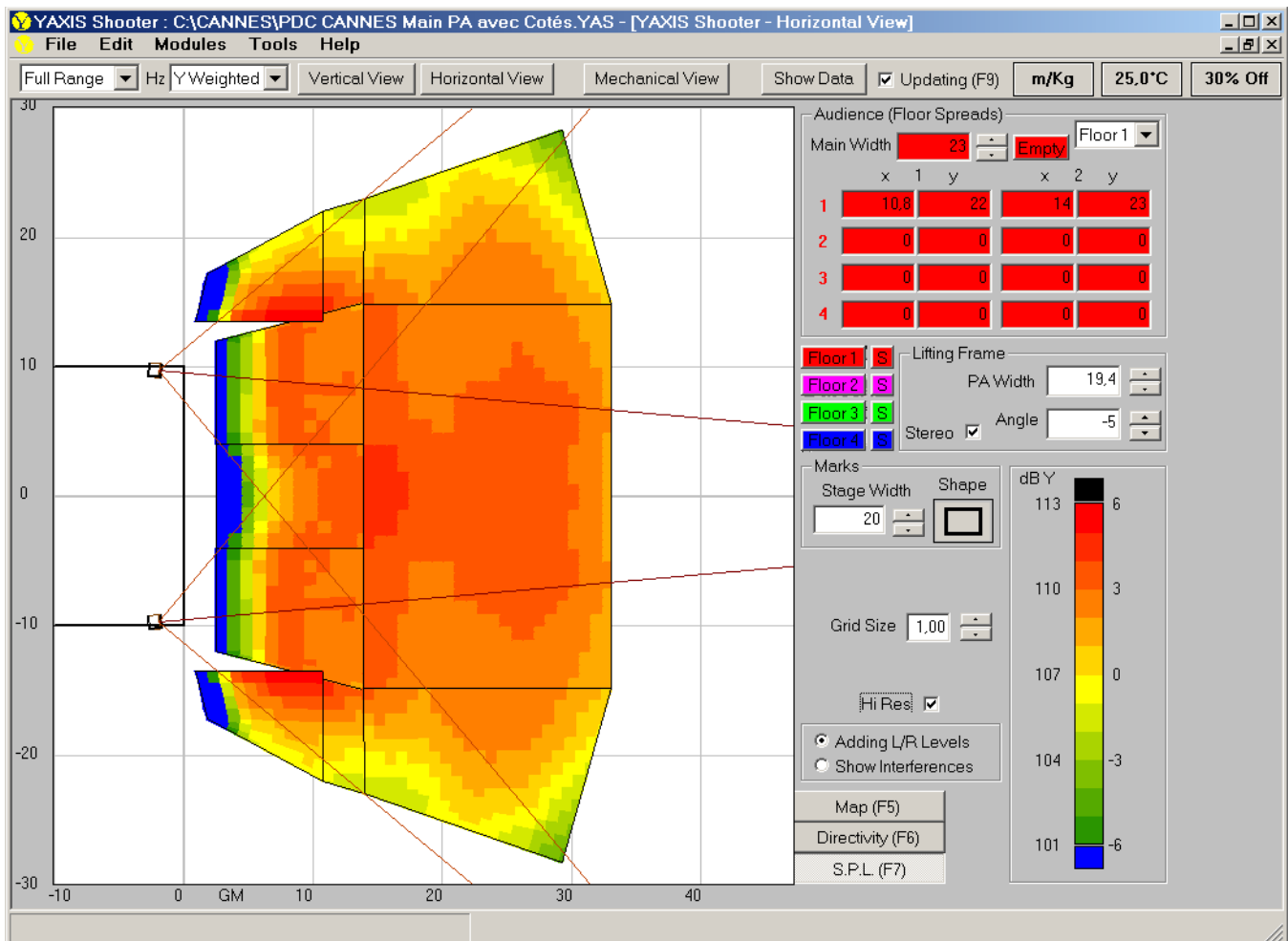

Introduction

The purpose of this guide is to help new users in their first setup with the Adamson Shooter[®] predictive software for Adamson Y-Axis and SpekTrix speaker systems. Further detail can be obtained from the Adamson Shooter[®] User Manual and is recommended for all users. All users should also attend Adamson Certification Training.

Disclaimer

The Adamson Shooter[®] Software, Shooter[®] Quick Start Guide and Shooter[®] User Manual are not meant to instruct the user in safe and standardized rigging methods.

Requirements

1. Microsoft Windows™ compatible computer version '98 or better
2. Internet connection or Shooter[®] Software CD
3. Measuring device or venue CAD drawings
4. Knowledge of Adamson Y-Axis and/or SpekTrix rigging systems
5. Working knowledge of coordinate geometry

Software Installation

1. Insert Shooter[®] CD or download Shooter[®] installation file. Shooter[®] may be downloaded at <http://www.adamsonproaudio.com/shooter> password: retoohS
2. Download file: "YAXISShooter 2.5.5.zip" or higher
3. Unzip the file and Click "Setup.exe" This will launch the installer. Follow the on screen instructions.

Start A New Project

1. Launch the "YAXIS Shooter v 2_5_5" Program
2. Under "File" Choose "Open"
3. Choose "BLANK.yas" and Click "Open"
4. Choose metric or standard measurement system in the top right corner by clicking ft/lb or m/Kg.
5. Click "Vertical View" to view the blank document.

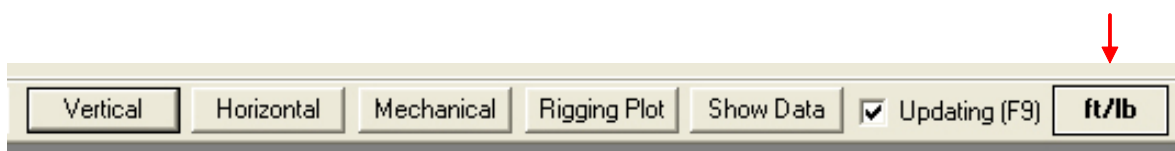

Defining The Space

In this graph, column "1" is the floor at the beginning point of section 1 (red), 2 (pink), 3 (green), or 4 (blue), and column "2" is the end point. A section can be an area of audience where the vertical pitch (incline) changes or a balcony is present. Like all CAD software (X) is used for the Horizontal plane and (Z) for the Vertical plane. (X) is always measured from the front of the stage and (Z) from the floor/ground level.

Audience (X=0 Edge of Stage)							
Floor	x	1	z	x	2	z	2D Calculator
1	LINK	3.6	0	21	0		Seats
2	LINK	23.2	0	33.5	2.5		Seats
3	LINK	35	2.5	39.6	3.8		Seats
4	LINK	41.8	4.2	54.4	8.5		Seats

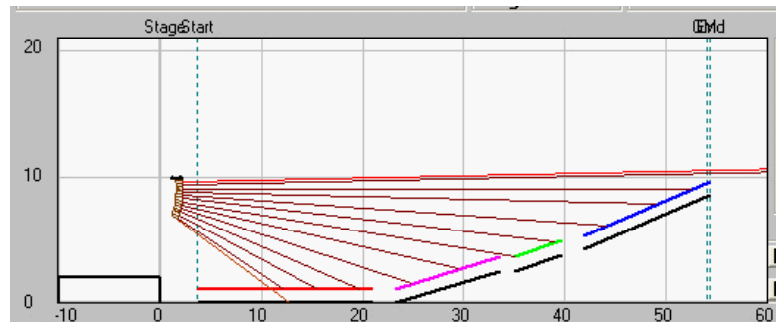

1. In section 1 column 1x, place the distance between the front of the stage and the first row of audience.
2. In section 1 column 1z, place the height of the floor. (Usually "0" for the first level)
3. In section 1 column 2x, place the distance between the front of the stage and the last row of audience in this section
4. In section 1 column 2z, place the height of the floor at the last row of audience in this section.
5. To add another standing/seating area (section 2) which is continuous with section 1, press "LINK" (automatically places the end distance of a section for the beginning distance of a new section hence connecting the two), or add it manually to 1x of the pink row.
6. If section 2 has an elevation starting immediately at the front row, such as a balcony, do NOT link these sections, but place the distance value manually and add height value to pink 1z.
7. In section 2 for column 2x, place the distance between the front of the stage and the last row of the second section. For an elevation add the height of the floor at the last row of section 2 to 2z.

Continue to include all audience sections. One can switch between "Stand" or "Seats" (to adjust the average ear height).

8. Adjust "Stage Height" and "Offset" if desired.

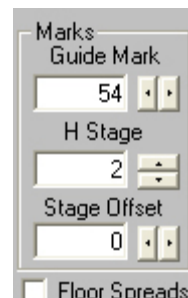

Speaker Selection

The software can determine the ideal quantity of boxes and the location of the rigging frame, for a given space, however practical limitations will need to be determined by the user. The software will make it readily apparent if you do not have enough boxes to cover the audience evenly, especially in the case of vertical coverage.

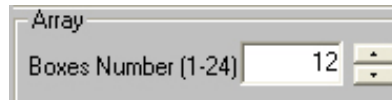

▼	1	▲	-1.2
▼	2	▲	-3.3
▼	2	▲	-5.4
▼	2	▲	-7.5
▼	3	▲	-10.5
▼	4	▲	-14.7
▼	4	▲	-18.9
▼	4	▲	-23.1
▼	5	▲	-28.2

1. Based on the number and model of boxes in stock, enter the quantity you are likely to use per side in the application.
2. Enter the model of boxes you plan to use in the drop down menus. (E.g. Y-10K = Y10's with Kevlar drivers, S8-W = SpekTrix Wave)

Locating The Rigging Frame

A balance must be found between what is best for sound quality and what is practical for the venue application.

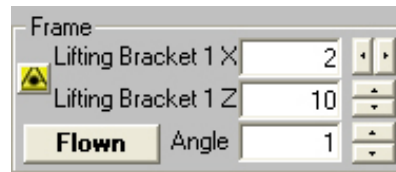

1. Choose either "Flown" or "Stacked"
2. Assess which factors are predetermined by the venue and enter them. For example, the array might need to stay at a certain height for audience line of sight, or the array might need to be a set distance from the front of the stage because of the venue's rigging points.
3. 1X determines distance from stage, 1Z Height of the array.

It is often useful to hit "AUTO SHOOT" at this point, to get a starting height and frame angle.

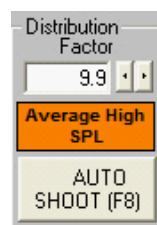

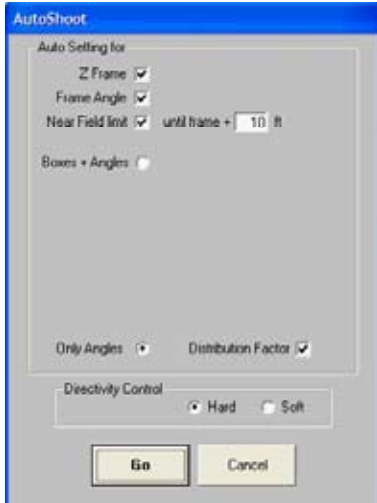

1. Choose "Z Frame" to allow Shooter to choose the optimal height for the rigging frame.
2. Choose "Frame Angle" to allow Shooter to choose the optimal Angle for the rigging frame.
3. Choose "Near Field Limit" to start Shooters calculations at a defined distance from the front of the Audience. Many applications require the use of low power front or down fills.
4. Choose Boxes+Angles if you want Shooter to determine the optimal amount of boxes for the application. Otherwise choose "Only Angles".
5. Press Go.

Adjust Frame And Box Angles

Keep in mind that what you are trying to achieve is a practical balance between, speaker placement, vertical coverage, equal SPL between front and rear audience members, and number of boxes to be used.

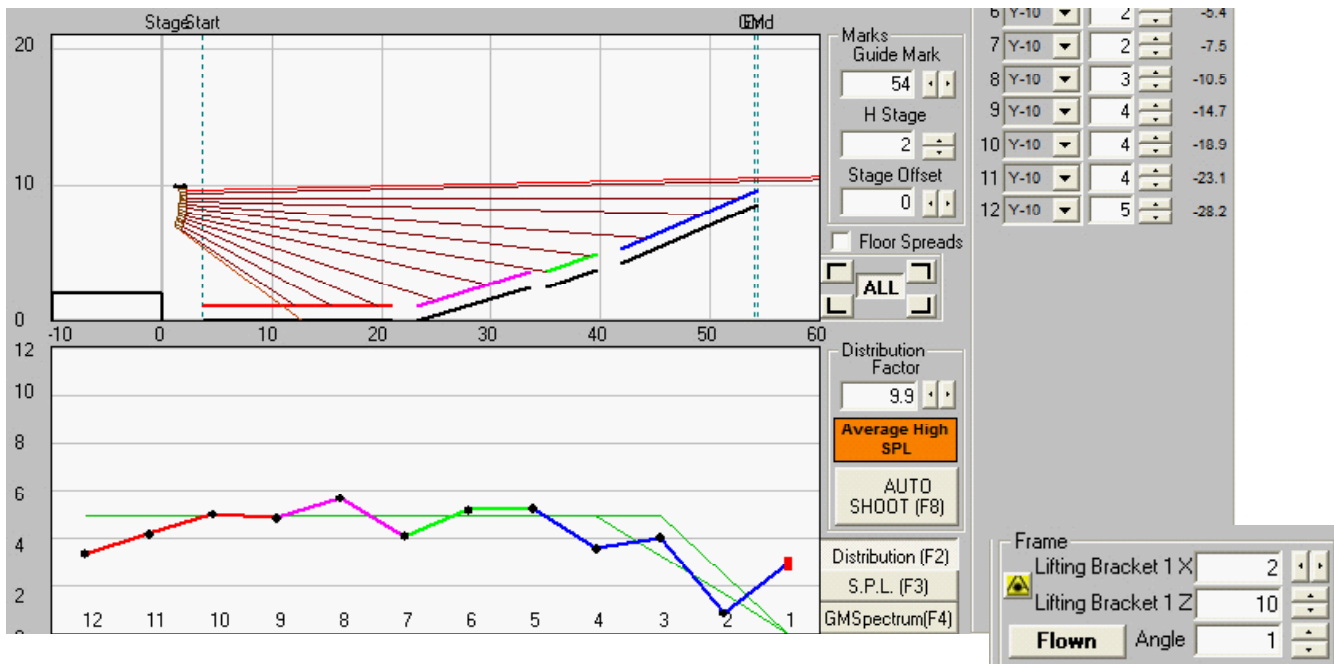

1. Hit S.P.L (F3) to see results. To adjust desired SPL level, scale "Distribution Factor" up or down.
2. Vary the angle and height of the rigging Frame and the Angles between boxes to achieve even SPL coverage.

Horizontal View

It's useful flip back and forth, between "Vertical" and "Horizontal View"

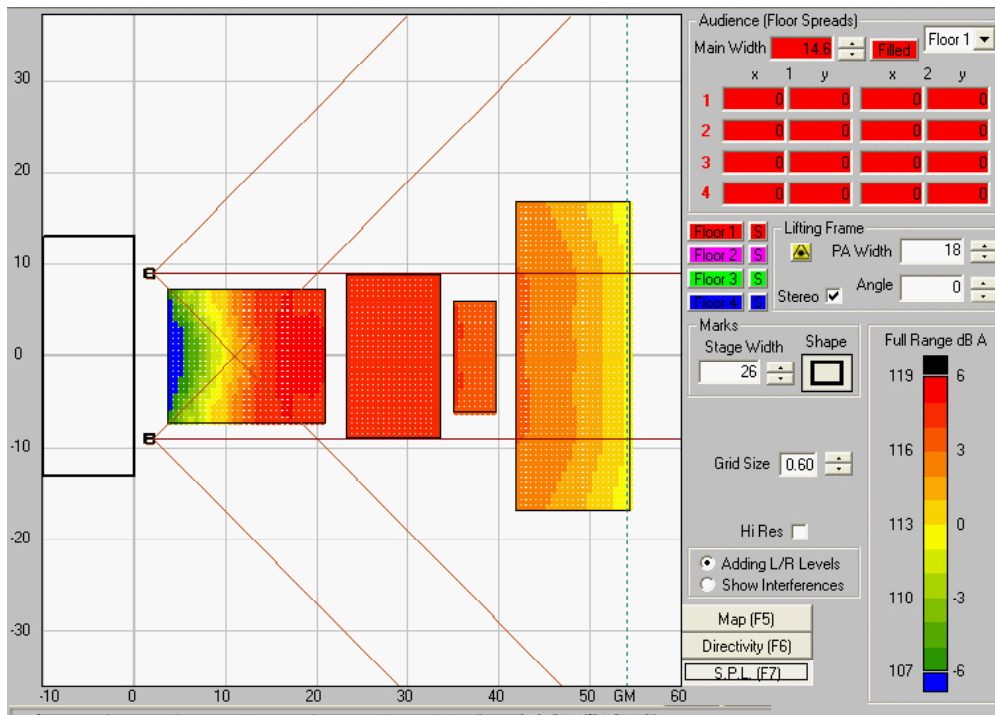

-While working, make sure you're in Map Mode (F5), when checking design switch to S.P.L. Mode (F7) to get a feel for the coverage. (S.P.L. Mode (F7) recalculates coverage after every change, thus slowing down the design process)
 -One can also adjust the P.A. system Width and Angle, as well as the Stage Width and Shape in the "Horizontal View". To work on a single rig, (E.g. a "centre cluster") turn off "stereo".

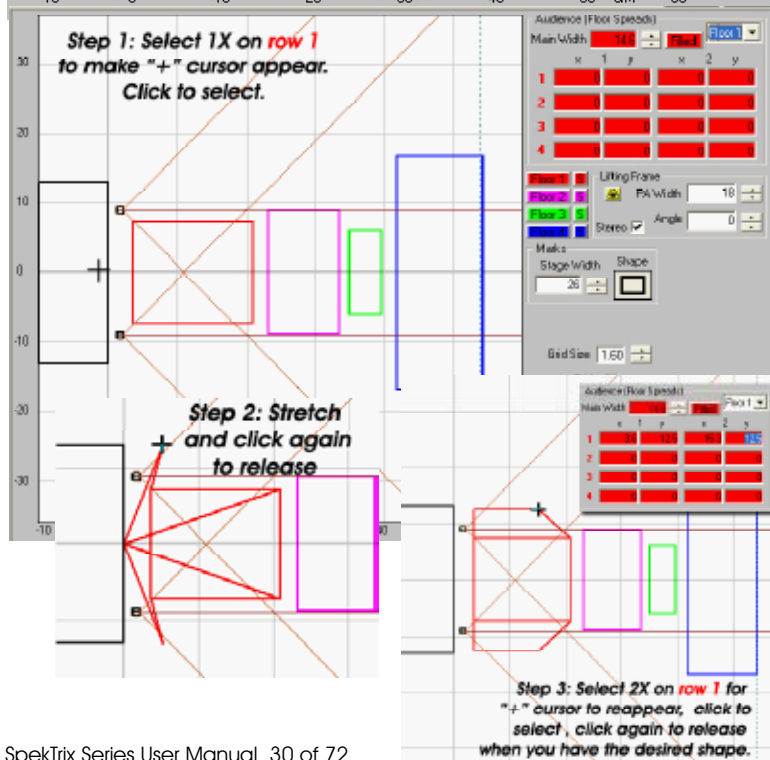

1. For drafting more complex areas select 1X in row 1. a "+" cursor will appear at the front of the stage.
2. "Click" on the "+" and stretch to determine the shape of the first row of the audience. "Click" to release when cursor is in the desired place.
3. Select 2X to determine the shape of the last row of floor level 1.

Remember you can also enter values manually. Continue to row 2, 3, 4, if floor level 1 requires more complex shapes. To switch to floor level 2, 3 or 4, use the drop menu on top of the page.

4. Click on "Grid" and adjust grid size. For a more detailed S.P.L. calculation, choose a tighter (smaller) grid size and vice versa, then click S.P.L. (F7) to see the coverage.

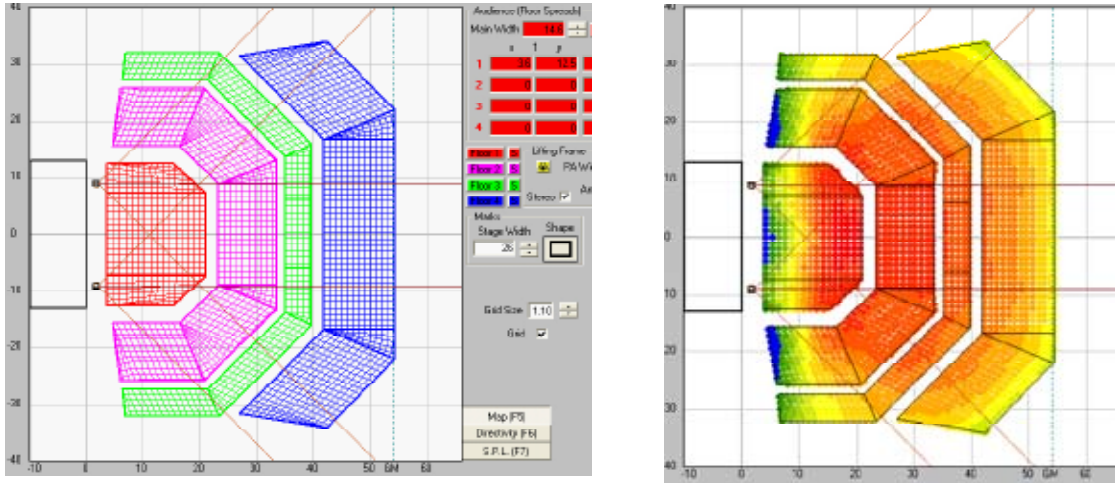

Summaries can be obtained by clicking "Mechanical View" for illustrations of the array and rigging frame, "Rigging Plot" for key rigging measurements. Both can be printed out as a "screen shot" and distributed to the rigging crew as a handy reference sheet.

(Press "print Scrn" on your keyboard, "Open" a new project in 'Microsoft Paint', 'Adobe Photoshop', or any other picture manipulation program and paste it for resizing and cropping. You can also paste it into a 'Word' document and print as is.)

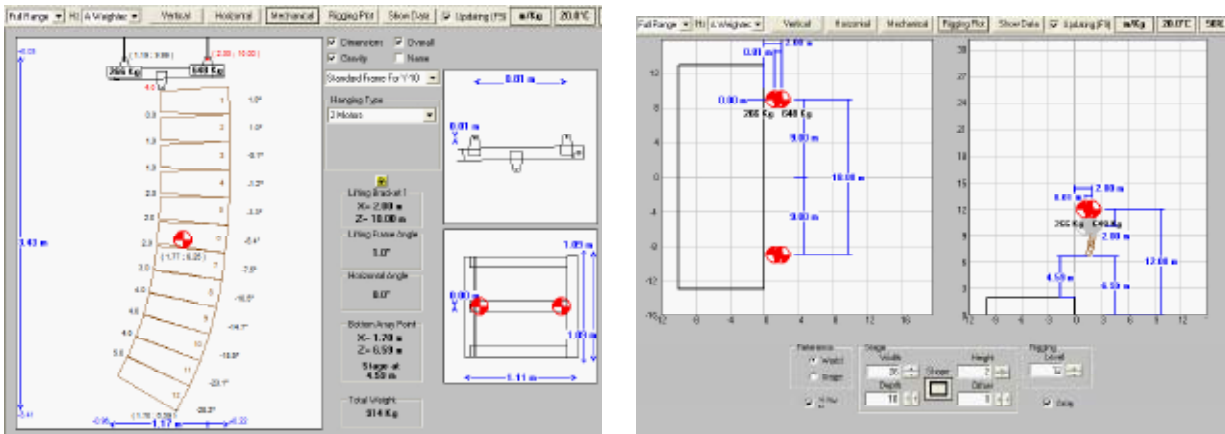

For a "Shooter user sheet" with no illustrations go to the "File" menu and click "Print User Sheet".

Keep in mind that Shooter has many more detailed features, which are outlined in The Adamson Shooter User Manual.



3.0 Total System Approach



Adamson Systems Engineering has long been using Lab.gruppen amplifiers and XTA processors to power and process SpekTrix Systems. All of our processor settings such as gain structure, equalization, time and phase alignment have been derived from extensive testing using this specific equipment combination. The use of this equipment evolved into a complete system solution, adapted by Adamson partners around the world.

Recently Adamson has added LAKE processing as a supported solution, with a complete settings library available by request and on-line.

We recognize the benefits of completely scaleable system that can also use multiple elements from **Amplifier/Speaker load balancing.**

To create a balanced amplifier load format common to all SpekTrix systems, Adamson Systems Engineering designed a specific driver compliment.

Each SpekTrix:

- 1) One 8 Ohm low frequency driver on pin 2 +/-
- 2) One 8 Ohm midrange driver on pin 3 +/-
- 3) One 8 Ohm high frequency driver on pin 4 +/-

Setting up processors and amplifiers

Processor settings, available for download on our website, are set in conjunction with the appropriate settings on the amplifier, normally set at 29dB or 32 dB of gain. Please assure that these settings are correct and correspond with the processor settings when configuring your set-up.



NOTE: Use only factory recommended equipment and settings. If you are using amplifiers and/or processing other than our example, please consult the manufacturers specification and instruction manual to assure that gain structures, limiting, equalization and connections are set up in accordance to our speaker specification. Failure to do so will result in inaccurate performance and risk of irreversible and /or personal damage, and thereby voiding warranty.

For Lab.gruppen, to link inputs and set the amplifier gain, the manufacturer provided an 8-switch dipswitch on the back of the amps. The center switches should be in the "up" position. and the gain should be set to the appropriate combination on switch 1,2,3 for channel B, and 6,7,and 8 for channel A. The example is set at 29dB. Link parallels input A to input B. To unlink amplifier channels A and B, move the two center switches, 4 and 5, to the down position. This will allow the user to have separate inputs to channel A and B of the amplifier.

3.1 Turnkey Solutions

Adamson Turnkey Solutions can be ordered complete with Power Distribution panels and A.I.D. Panels. There are 110v or 220v units available for Power Distros, and both A.I.D. Touring and Install versions are available with both Socapex and NL8 cabling solutions.

A·I·D·PANE INSTALL SERIE



Part #'s:
Install w. Socapex # 900538
Install w. NL8 # 900511

Part #'s:
Touring w. Socapex # 900520
Touring w. NL8 # 900510

Adamson's Audio Integrated Distribution (A.I.D) panels were designed in consultation with FOH and system engineers to create a common standard of audio connectivity and distribution for all Adamson Y-Axis partners. It provides a recognizable, high quality interface standard for cross rental, co-production and dry-hire. Industry standard socopex and NL cables allows for fast and easy connectivity to- and from amplifier racks, with a variety of options for shared audio processing, bussing and distribution. The Panel minimizes clutter, extra equipment, cables, manpower and space, saving premium dollars to the equipment provider, and ultimately the client. Adamson Audio Integrated Distribution Panel is a 19" rack-mount unit, 2-U high and 10.25" deep. It provides front panel access to processor and amplifier in- and outputs, and is completely dynamic in configuration by using XLR and NL patch points on the back-face. For user manual go to www.adamsonproaudio.com/technical_support



A·C·PANEL

Part #'s:
AC Distro 220 Version
#920207

AC Distro 110 Version
#900537

The Adamson A/C Panel is designed to power Lab.gruppen amplifiers. The input can be modified for your unique needs. The outputs consist of 3 x single receptacle Hubbel TL3 30A (nema L5-30R) and 2 x duplex receptacle standard 20A. 1 duplex receptacle is located at the front for utilities. The Adamson A/C Panel occupies a 2 unit rack space and is 19 inches wide.



3.2 Pin Configuration Table

For your convenience, below is a pinout chart used in most of our products.

<u>Backpanel</u> <u>NL4 input</u>	<u>Frontpanel</u> <u>NL8 panel</u>	<u>Frontpanel</u> <u>SOCO 19pin</u>	<u>Splays</u> <u>2NL8</u>	<u>Splays</u> <u>4NL8 sub</u>	<u>Splays</u> <u>4NL4</u>
1A-1	1A 1-/+	1 - Pin 1,2	BRN 1-/+	BRN 1-/+	BRN 1-/+
1A-2	1A 2-/+	1- Pin 3,4	BRN 2-/+	BRN 2-/+	BRN 2-/+
1A-2	1A 3-/+	1- Pin 7,8	BRN 3-/+	RED 1-/+	RED 1-/+
1A-4	1A 4 -/+	1- Pin 9,10	BRN 4-/+	RED 2-/+	RED 2-/+
1B-1	1B 1-/+	1- Pin 11,12	RED 1-/+	ORN 1-/+	ORN 1-/+
1B-2	1B 2-/+	1- Pin 13,14	RED 2-/+	ORN 2-/+	ORN 2-/+
1B-3	1B 3-/+	1- Pin 15,16	RED 3-/+	YEL 1-/+	YEL 1-/+
1B-4	1B 4-/+	2- Pin 1,2	RED 4-/+	YEL 2-/+	YEL 2-/+
2A-1	2A 1-/+	2- Pin 3,4			
2A-2	2A 2-/+	2- Pin 5,6			
2A-3	2A 3-/+	2- Pin 7,8			
2A-4	2A 4-/+	2- Pin 9,10			
2B-1	2B 1-/+	2- Pin 11,12			
2B-2	2B 2-/+	2- Pin 13,14			
2B-3	2B 3-/+	2- Pin 15,16			
2B-4	2B 4-/+				

Electronic colour code

Black	0
Brown	1
Red	2
Orange	3
Yellow	4
Green	5
Blue	6
Violet	7
Grey	8
White	9

This is the code used to identify values on, for instance, resistors or capacitors, or to identify cable numbers in multiple cable runs. By using rings of colours in a specific pattern, one can represent numerical "base 10" counting systems. To represent numbers 1 thru 9, only one colour ring is used. A second ring of colours allows 2 digit numbers, 0 to 99, a third ring 0 to 999 and so on. A black ring represents all zero values or columns not used.

For example, the number 10 in a three-ring code is represented by black-brown-black. The number 256 is represented by red-green-blue. A value of 1 in a three-ring colour code would be represented by black-black-brown.

3.3 Amp and Pin Configurations

Product Specific Amplifier and Pin Configurations are available by request from Adamson Systems Engineering +1 905 982 0520 And also available at our website's Technical Section:
www.adamsonproaudio.com/technical_support/amp_configurations
www.adamsonproaudio.com/technical_support/pin_configurations

PDF Example of a Standard Configuration for 4 SpekTrix with 2 SpekTrix Subs flown, using NL8 Connectors.

Note: all examples integrate Lab. gruppen amplifiers and Adamson AID Panels and Power Distribution Panels.

For more details on these panels please download user manuals found on our website
www.adamsonproaudio.com/technical_support/user_manuals

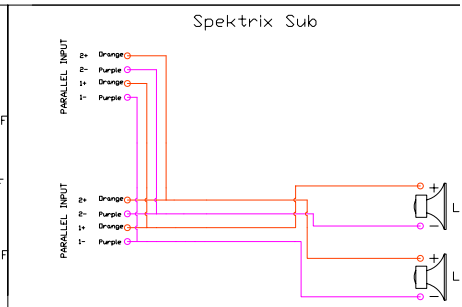
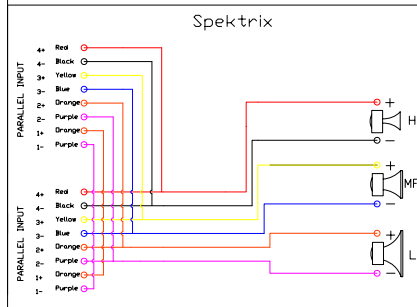
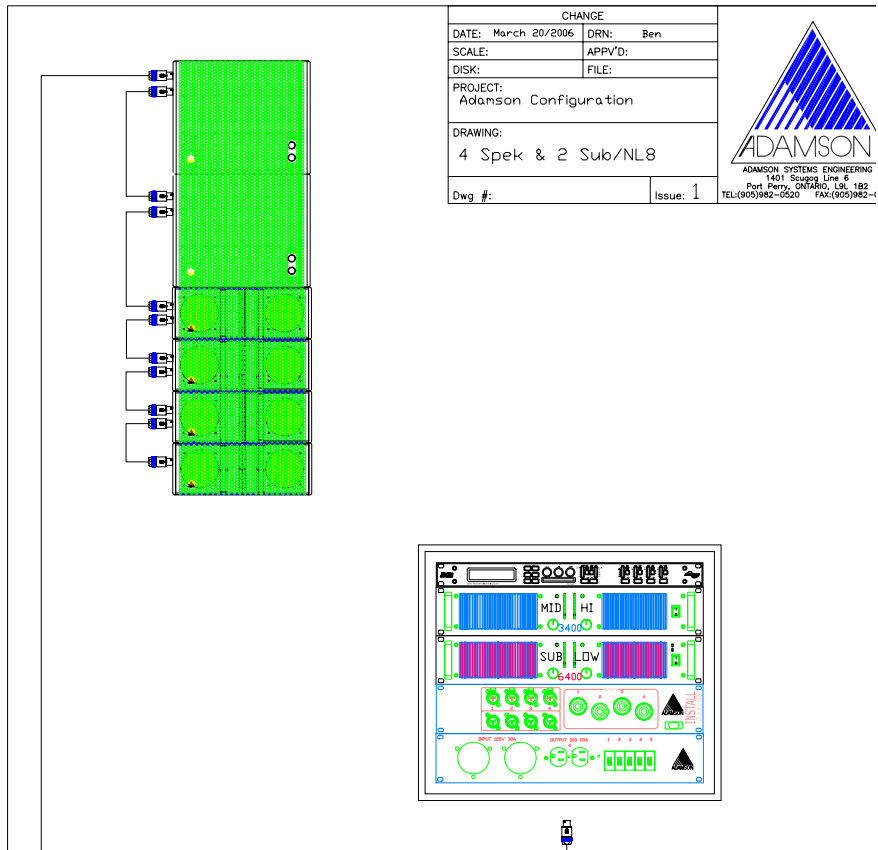



3.4 Presets for Processors

Adamson Systems Engineering Specified Racks include XTA processing. The idea behind this is the facilitation of cross rentals between companies, as well as producing the best possible sound with Adamson Speakers. By popular demand LAKE and PLM setting are also available.

Please contact Adamson Systems Engineering 905-982-0520 or visit our technical support section on our website: www.adamsonproaudio.com/technical_support for up-to-date settings downloads.

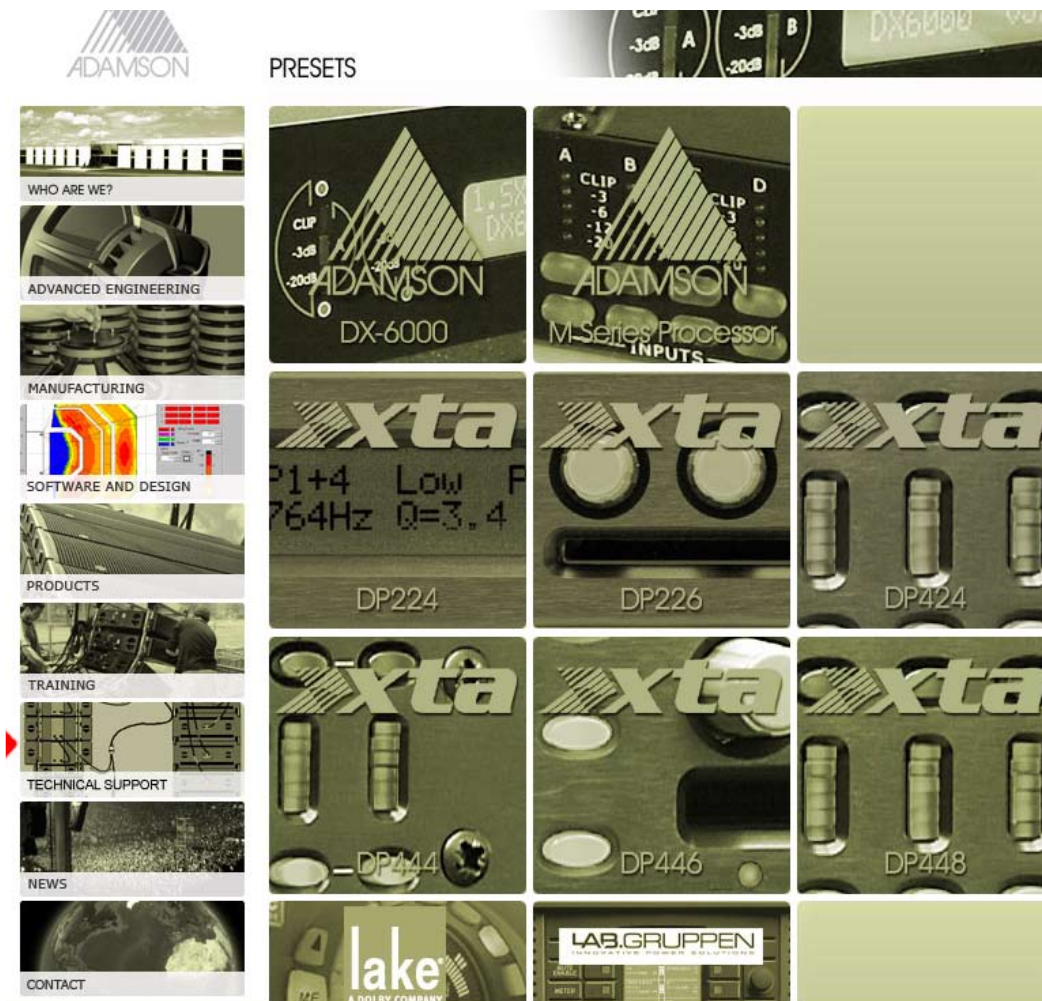

4.0 Rigging and Cabling Instructions



4.1 Precautions

WARNING

DO NOT put your hands between enclosures.
SOME AREAS MIGHT HAVE PINCH HAZARDS!

Make sure a certified rigger installs your rigging points and hoists. Confirm that the rigging points are certified for the amount of weight you plan to hang. Refer to Adamson Shooter's Mechanical View for load and rigging details.





4.2 Flying the Array

Installing the SpekTrix System is simple, fast and safe.

A SpekTrix array can be installed in less than 10-15 minutes depending of the lenght of the array.

For a efficient and fast installation, (although the spekTrix system can be installed by a single person), a system Technician, a stage hand and a rigger who in charge of the hoist remote, should be present.

The technician and stage hand are in charge of prepping the array prior to installation.

The array geometry and positioning is determined by the Shooter Software prior to installation. it's important to have the design on a computer screen or as a print out available, to easily determine frame and cabinet angles among other details.

You can also refer to the "SpekTrix Configuration Examples" for further ideas on the diverse uses and set-ups achieved with the SpekTrix Series.

Array positioning of zero through five degrees per enclosure can be set without the use of any additional hardware Using the built-in AIR™ system. Six precise rigging angles on logarithmic increments are implemented by the insertion of stainless steel push pin into precision machined sliding bars that extend from their home position to link the rear of the enclosures.

Between first SpekTrix Enclosure & rigging frame Always use position 2



SpekTrix Subs flown in Cardioid with an underhang of 8 SpekTrix cabinets.



6 SpekTrix flown

4.2 Flying the Array

There are a few ways of flying the SpeTrix system; depending on the number of riggers, and whether you're flying SpekTrix Subs as well.

Example 1: Flying with Subs

1. Begin by attaching the rigging frame to the top sub. One can choose to keep the Frame Attached to the Sub during transport.
2. attach your motor/s onto the rigging Frame
3. Release pins from the second sub



4. Turn the bottom Sub 180 degrees if you'd like to fly it in a cardioid format. If not, skip steps 3 & 4.
5. Connect top and bottom sub with an NL8 cable and Attach another cable to the bottom sub's lower socket.

1. & 2.

3.

6. Release the dolly pins. (place the pins back into the cabinet as to not lose any pins.)

4.

5.



4.2 Flying the Array

7. Set-up and Calibrate Inclinometer and reader to zero using a flat surface

7.



8. Attach Inclinometer to the top of your rigging frame.

9. Adjust the frame angle to the proper position according the inclinometer reading.



8. & 9.

10. & 11

10. Hoist subs up until the bottom box is at a working level.

Note: When arraying alone (or if you simply prefer this method of rigging) one must prepare the rigging positions on the entire SpekTrix 4-stacks prior to flying the system. When preparing enclosures, reference your Shooter design, and make sure that when setting the angles, you work your way from the bottom box to the top box.

E.g. If there are 8 Spektrix enclosures in your design, one dolly will have the settings from box 8 (at the bottom) to box 5 (on top) and the next dolly from box 4 to box 1. To attain a spaceless connection between the SpekTrix Sub above to the first SpekTrix enclosure, **the top SpekTrix box rigging wheel position must be set to 4.**

11. Wheel the SpekTrix stacks underneath the subs, lower the array of subs so that the rigging wheels on the top SpekTrix box line-up and pin together with the provided push pins. Lift array to a comfortable working height and wheel the second SpekTrix set underneath. Lower array so that you can pin the next four to the array using built in AIR rigging wheel pin.

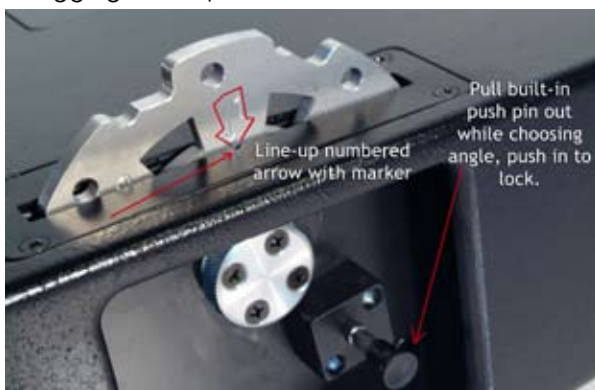

3. (Next Page)

4.2 Flying the Array

When arraying with someone else, or without having had prep time between events and a venue requires a new design, it might be faster to configure the array box by box. This method requires a minimum of 2 persons.

1. Place a person on both sides of the array with a possible third person operating the motor.
2. Follow the steps to hang the subs onto the frame. p. 40
3. Cabinet 1: Unhook the bottom push pin to release the enclosure from the stack, pull the rigging wheel's safety pin outward. Change the wheel position into the desired position (first enclosure should be set to 4 to attain a gapless array) Push pin back into place.
4. Lift the enclosure, and place the push pin into place (on the previous cabinet, the rigging frame or in the cabinet above) to hold the boxes together.
5. Release the following enclosure's pins, turn the wheel to desired position push the pin back in.
6. Lift and pin to the previous enclosure.

4.



5.



6.



7. Continue this method until all boxes are pinned together. If needing more room to work, bring the motor up to a desired level every few enclosures.



7.



8.



9.

8. When working on a longer array, one might want to attach cabling every 4 boxes, in order to reach the top enclosures.

9. Wheel the next stack under the array and follow the previous instructions.

FOR CABLING INSTRUCTIONS SEE NEXT PAGE

4.2 Flying the Array



1. **When arraying SpekTrix directly to the Rigging Frame to attain a gapless contact, place the top enclosure's rigging wheel to position 2.**

2. After setting-up and calibrating the Inclinometer, attach it to the rigging frame and set your frame angle according to the shooter file.

1.

2.

Cabling

1. Make sure that every box is plugged in according to factory suggested amp configurations. (See next 2 pages for examples) You can also refer to our standard amp and pin configurations PDF's available on our website. www.adamsonproaudio.com/technical_support/amp_configurations/index.htm or call 905 982 0520 for custom set-up and support.

All SpekTrix Series enclosures use NL8 connectors between boxes.

2. Loop all cabling at the back neatly together and hook to the rigging frame or tie it close to the array using a strap and a handle pocket, in order to keep them neat, to avoid getting cabling stuck or pulled off.

1.

2.

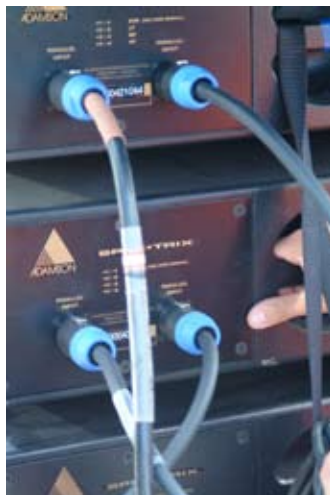

4.2 Flying the Array

2 SpekTrix Subs with 8 SpekTrix - NL8

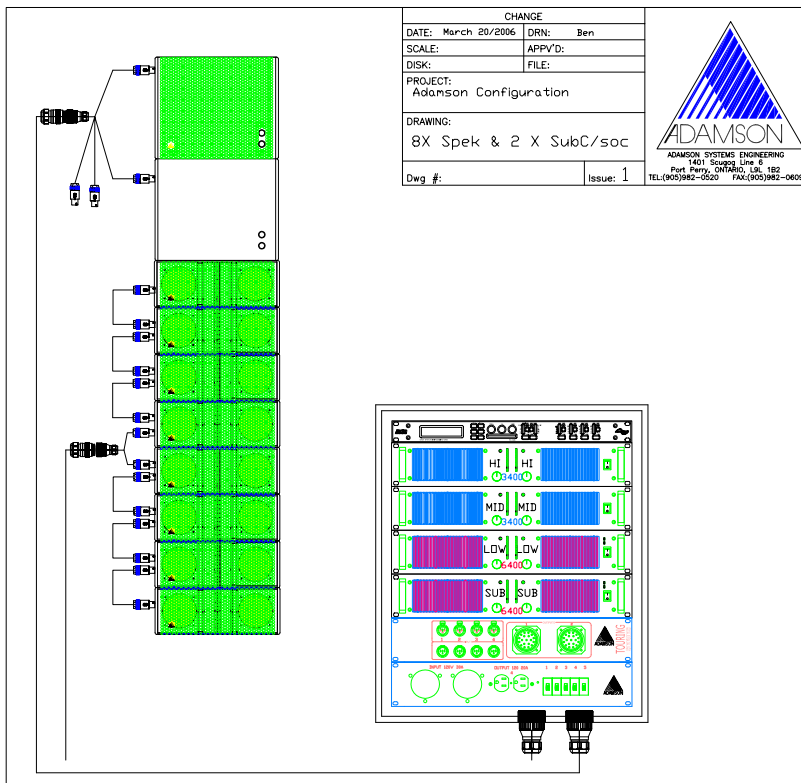
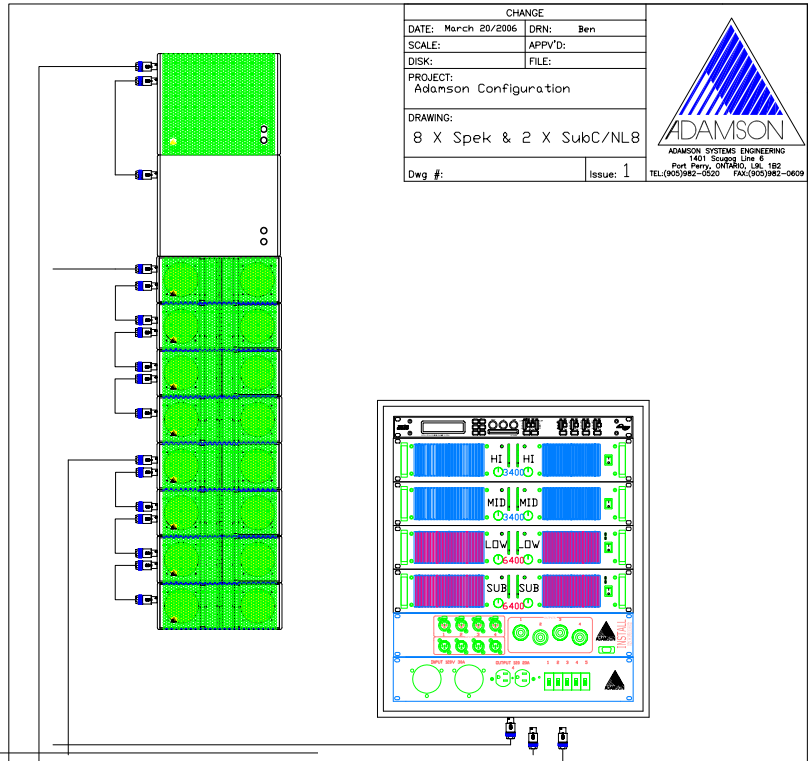

2 SpekTrix Subs with 8 SpekTrix - Socapex

4.2 Flying the Array

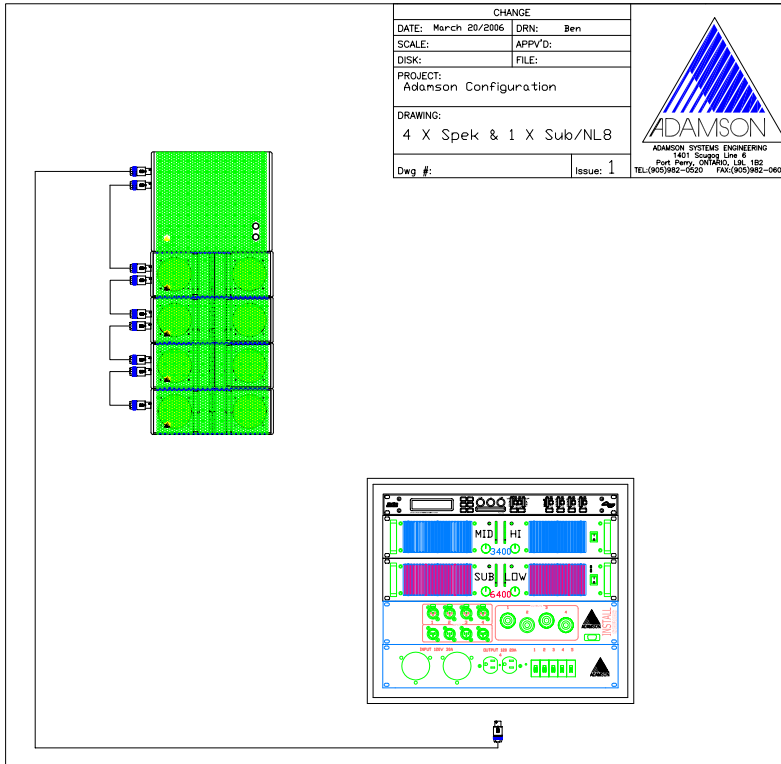

1 SpekTrix Sub with 4 SpekTrix - NL8

4 SpekTrix Subs with 8 SpekTrix - Socapex

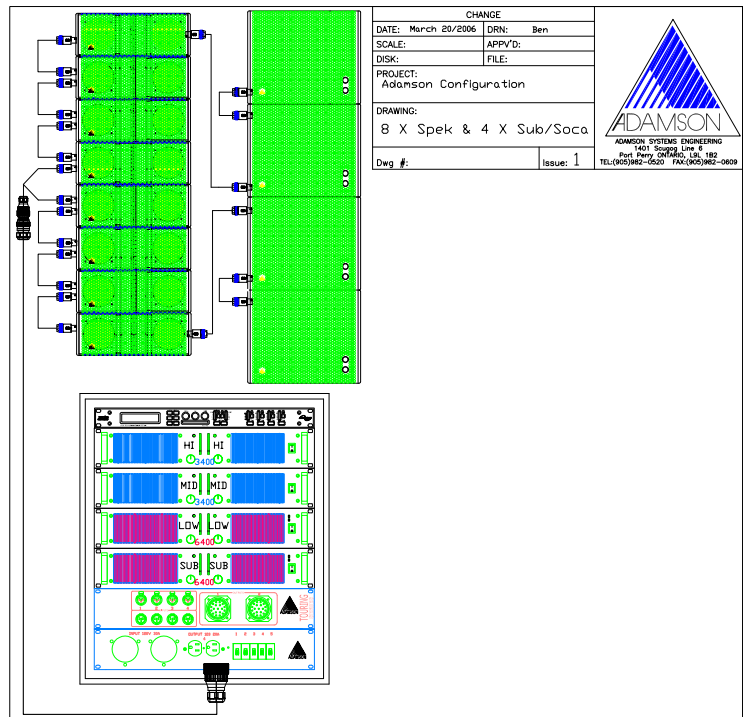

4.2 Flying the Array

1.



2. & 3.



1. Lift slightly and confirm frame angle using inclinometer and laser. When using a 2 point hang with the SpekTrix, you can adjust the frame angle using the motors once it is fully up in the air.

2. Loop the measuring tape to the bottom handle of the array, lift to the desired trim height and release the measuring tape when ready. Remember to double up the length when using a "loop" method. You can also use a piece of tape to attach it to the bottom enclosure, and pull the measuring tape out when ready. (Note: This method might leave an awkward piece of tape hanging off the bottom box)

3. Check angle once in proper trim height to confirm planned coverage.

4.3 Ground stacking the Array

SPEKTRIX PLATE: Standard Stacking Plate for SpekTrix

The "Standard Stacking Plate" is used to achieve angles of -3° to $+5^\circ$ between the first SpekTrix box and the rigging frame in a stacking configuration.

- 1) Insert the plate into the frame
- 2) Place the "Ball Lock Pin" in either; the "+" slot for positive angles, or in the "-" slot for 0° or negative angles.
- 3) Lock the plate with a second "Ball Lock Pin" in the desired position.

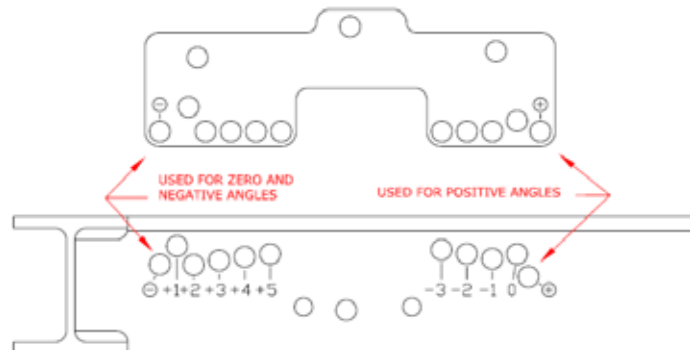

SPEKTRIX W PLATE: Extended Stacking Plate for SpekTrix and W

The "Extended Stacking Plate" is used to achieve negative angles of -13° to -5° between the first SpekTrix box and the rigging frame in a stacking configuration. It is also used to achieve negative angles of -8° to 0° between the first SpekTrix W box and the rigging frame in a stacking configuration.

- 1) Insert the plate into the rigging frame
- 2) Insert the first "Ball Lock Pin" into either "-" or "+" slot depending on the desired angle.

Remember that this plate's ZERO position achieves -10° for SpekTrix boxes, and -5° for the W boxes . Therefore:

Example 1: if the desired position for the first SpekTrix box is "-8", the first pin would be inserted into the "+" slot and second pin into the "+2" slot.

Example 2: If the desired position of the first WAVE box is "-7", place first pin in the "-" slot and the second pin in the "-2" slot.

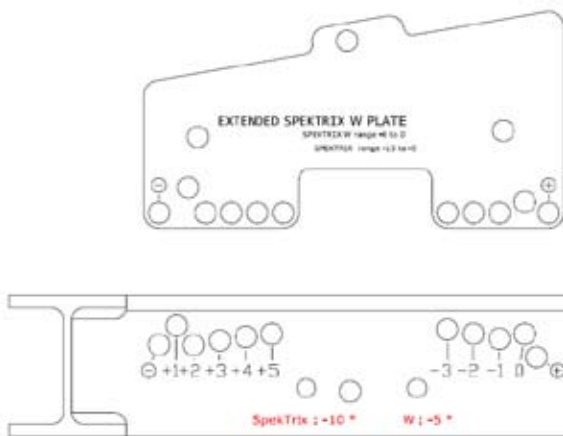

Position Indicated on the Rigging Frame	First SpekTrix W Box Angle (-5)	First SpekTrix Box Angle (-10)
+5	0	-5
+4	-1	-6
+3	-2	-7
+2	-3	-8
+1	-4	-9
0	-5	-10
-1	-6	-11
-2	-7	-12
-3	-8	-13



D.G. Biddle & Associates Limited

consulting engineers and planners

96 KING ST. E., OSHAWA, ONTARIO L3H 1B6 PHONE (905) 576-8500 FAX (905) 576-9730
e-mail: dgbbiddle@tdirect.com

November 4, 2005

Adamson Systems Engineering
1401 Scugog line 6
Port Perry, ON.
L9L 1B2

Attn: Jesse Adamson

Re: Structural Review of Spektrix Riggins System
Our File: 104521

Dear Sir,

Our office has been retained to structurally analyze the Spektrix speaker rigging system currently used to hang multiple Spektrix enclosures. We have analyzed the rigging in order to determine the maximum number of modules that can be hung while maintaining a specified factor of safety.

As instructed, we assumed that only the following materials are used in the rigging system:

- All Aluminum - 6061 T6 Alloy
- Stainless Steel Pins - Grade 303
- All other Steel - 44W Cold Rolled

As well the weights of the loudspeakers used in our analysis are as follows:

- Spektrix Enclosure - 28kg (62lbs)

Using the supplied rigging manual we performed a finite element analysis on both a vertically hung and a typical "J" shaped hug arrays only. We analyzed the individual rigging elements in accordance with CAN/CSA-S16.1-94, CAN/CSA-S138-94, and CAN/CSA S157 standards to determine the elemental failure loads. Following this we modeled a number of hung speaker arrays in order to determine the elemental stresses in the rigging from various rigging examples. This loading assumed that the weight of the individual module is distributed evenly throughout.

With a maximum eccentricity of 860mm (34") of the center of mass of the entire speaker array to the lifting point the Spektrix rigging system can support the following:

- 11 speakers with a 8:1 factor of Safety
- 15 Speakers with a 6:1 factor of safety
- 17 Speakers with a 5:1 factor of safety

Should you have any question regarding our analysis please contact our office at your convenience,

Yours truly,

D.G. Biddle & Associates Ltd.

D.D. Biddle, P.Eng.

5.0 SpekTrix Configuration Examples

Stacking Configuration - Example 1

Configuration: 4 ground stacked SpekTrix on 2 SpekTrix Subs using the SpekTrix rigging frame.

Application: Coverage of a 40 meter/130feet deep, level area with constant SPL front to back (6dB change) and wide horizontal coverage.

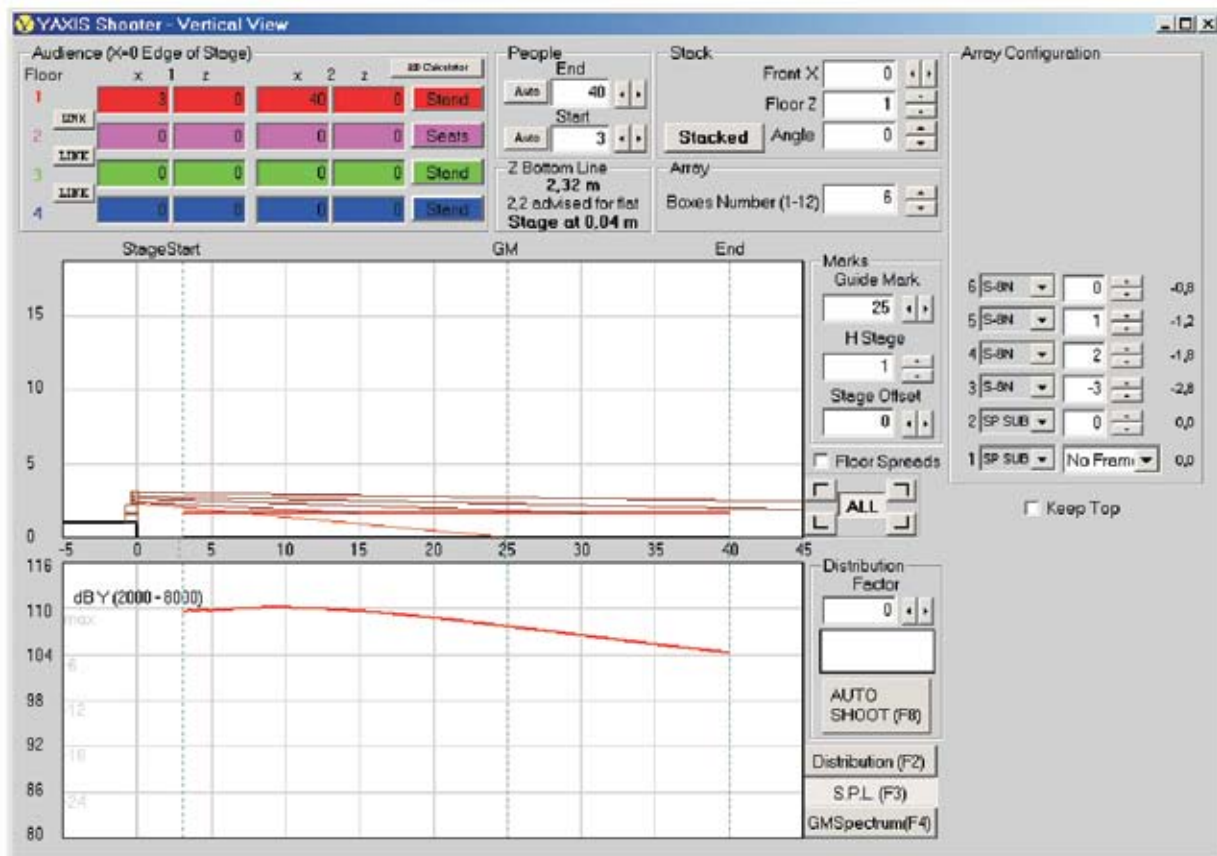
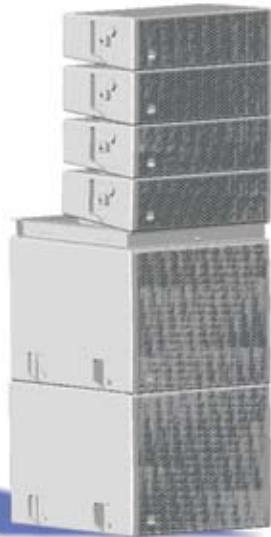

5.0 SpekTrix Configuration Examples

Stacking Configuration - Example 1

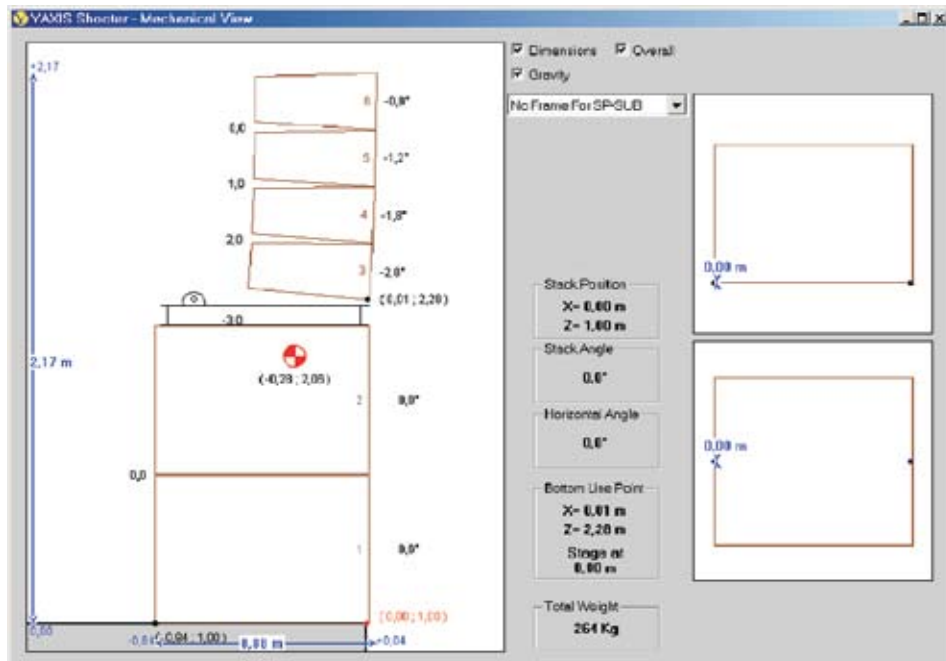
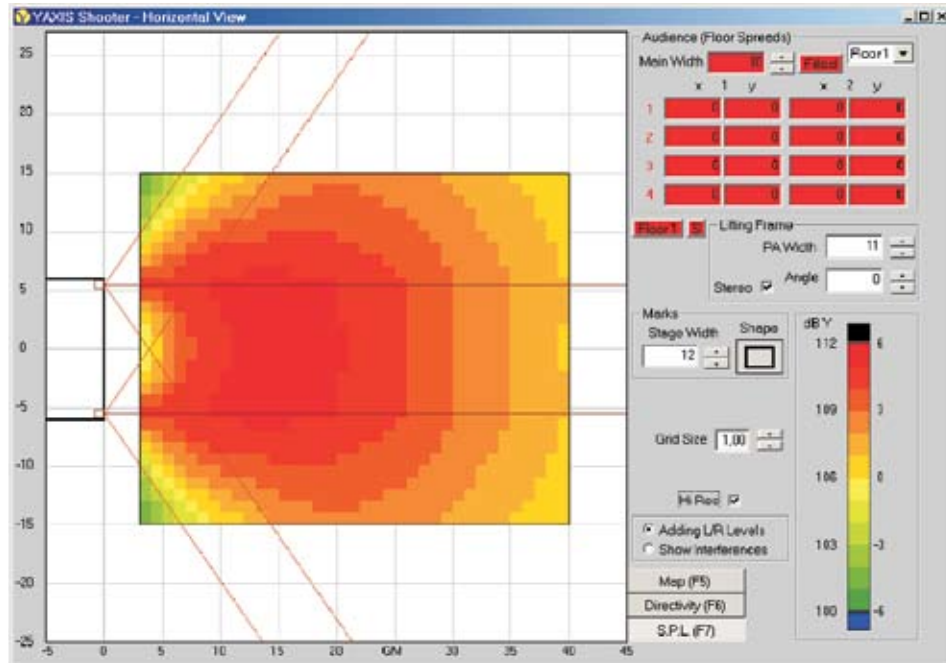



5.0 SpekTrix Configuration Examples

Stacking Configuration - Example 2

Configuration: 4 ground stacked SpekTrix on 1 SpekTrix Sub using the SpekTrix rigging frame.

Application: Medium size arena with less low-end demanding material.

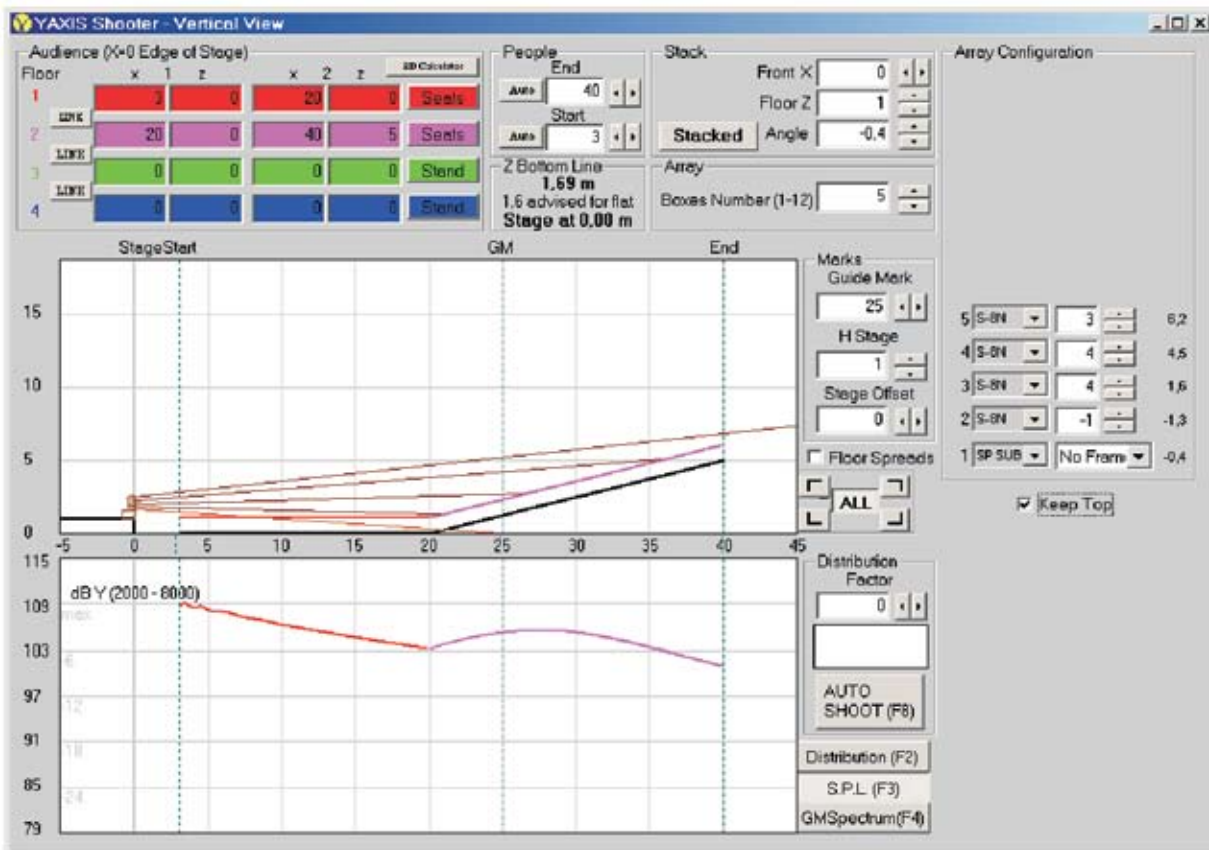
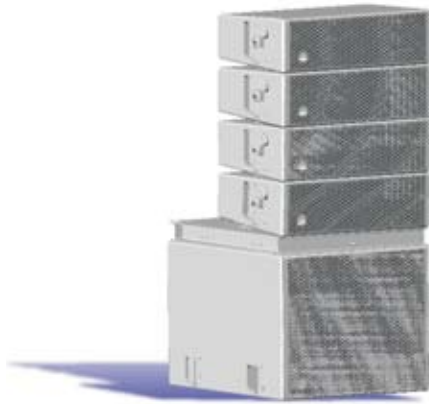

5.0 SpekTrix Configuration Examples

Stacking Configuration - Example 2

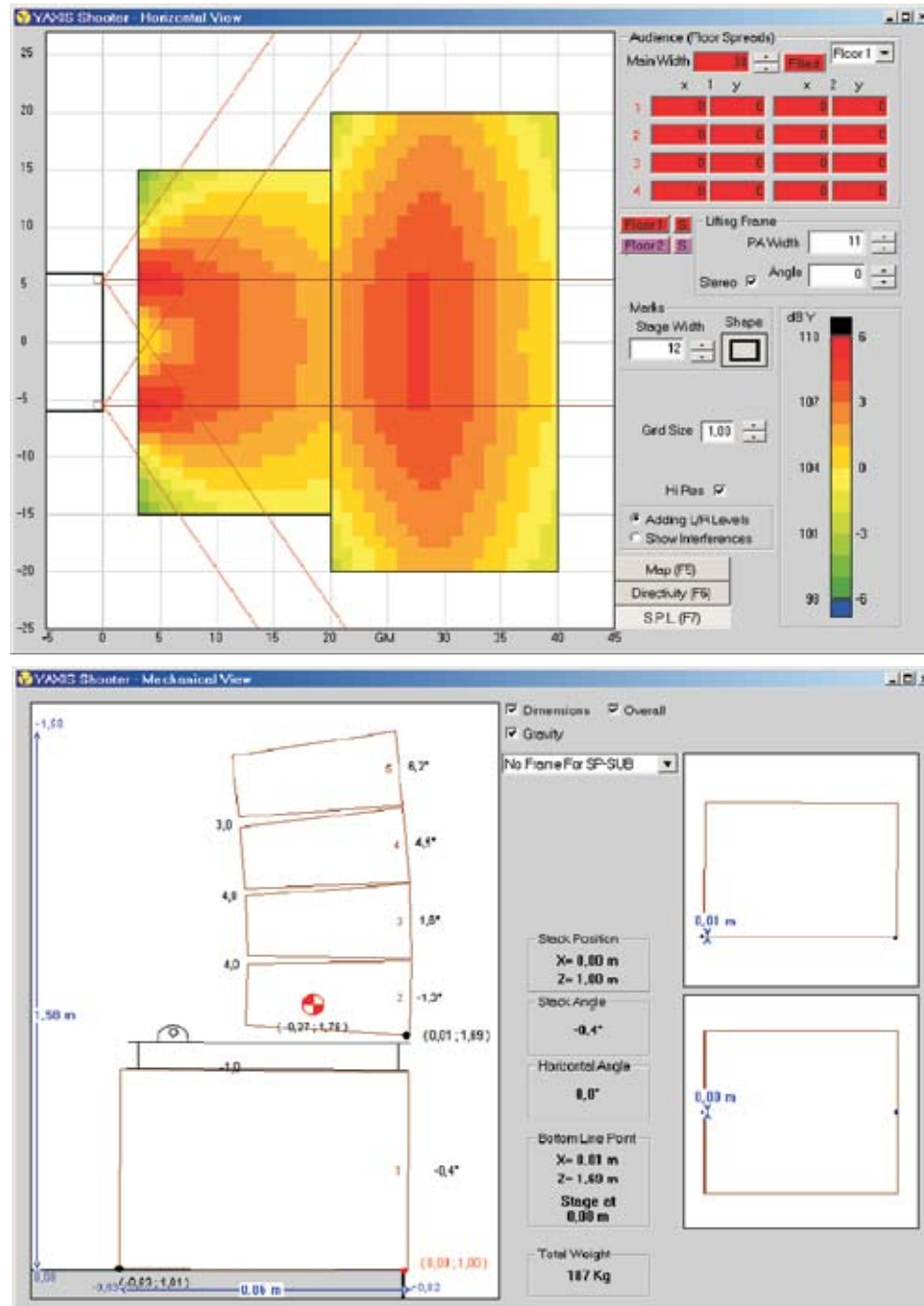



5.0 SpekTrix Configuration Examples

Stacking Configuration - Example 3

Configuration: 3 ground stacked SpekTrix on 1 SpekTrix Sub using the SpekTrix frame.

Application: Front fills only - not to be used as a main array

Note: The height of the array must be carefully adjusted with the Adamson Shooter™ software to avoid excessive SPL in the front rows.

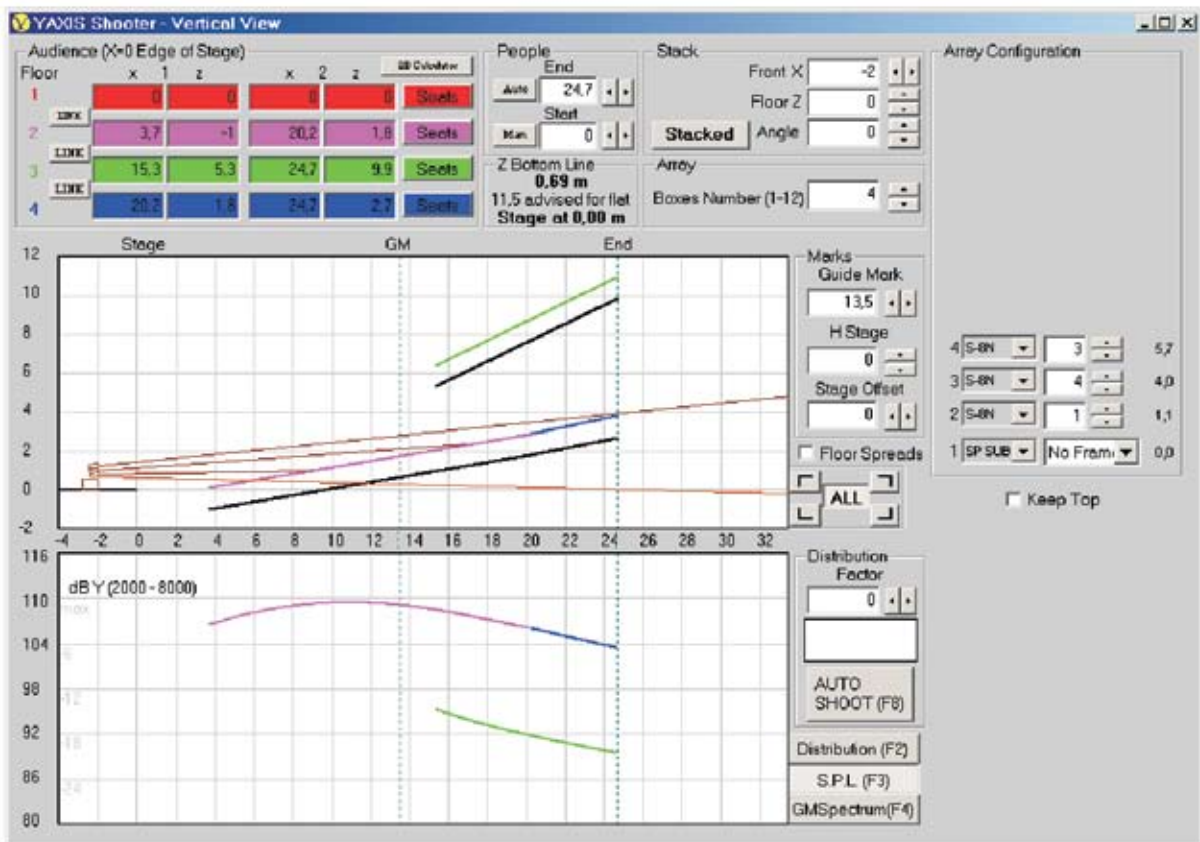

5.0 SpekTrix Configuration Examples

Stacking Configuration - Example 3

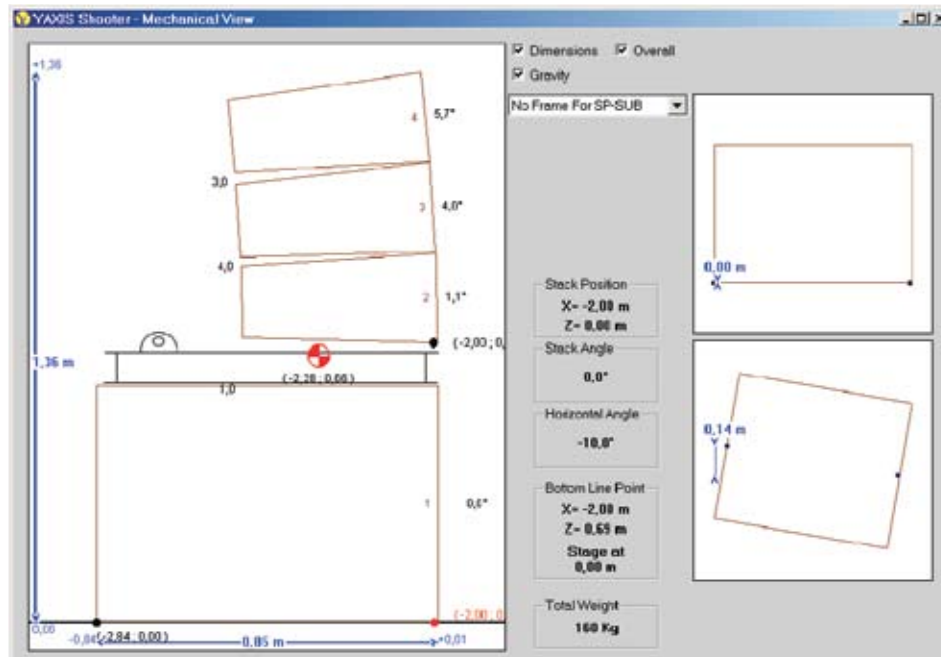
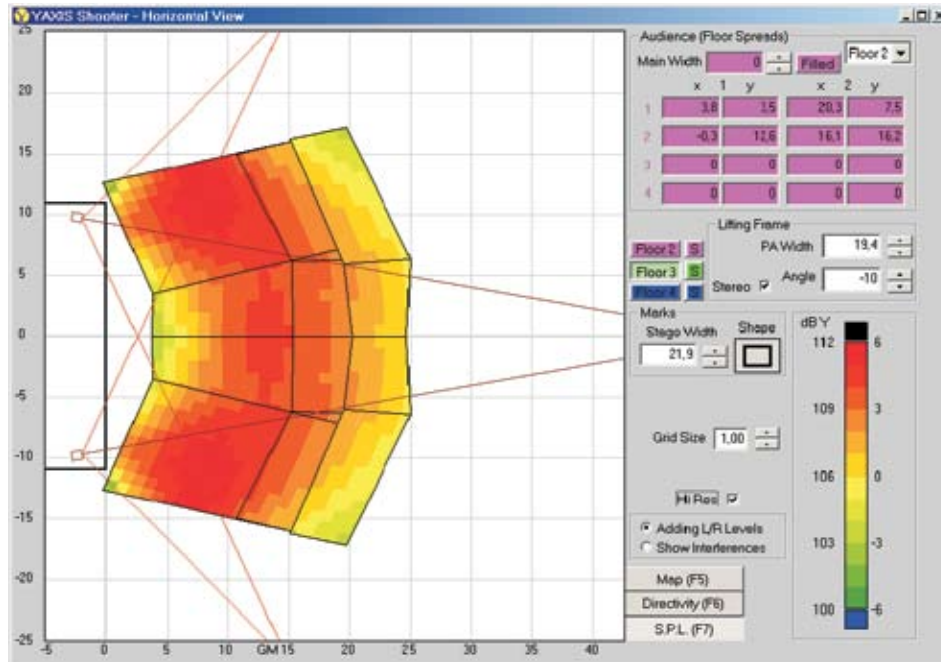



5.0 SpekTrix Configuration Examples

Stacking Configuration - Example 4

Configuration: 8 ground stacked SpekTrix using the SpekTrix rigging frame plus 2 - 4 SpekTrix Subs.

Application: Medium to large scale arenas where flying is not possible.

Note: The height of the array must be carefully adjusted with the Adamson Shooter™ software to avoid excessive SPL in the front rows.

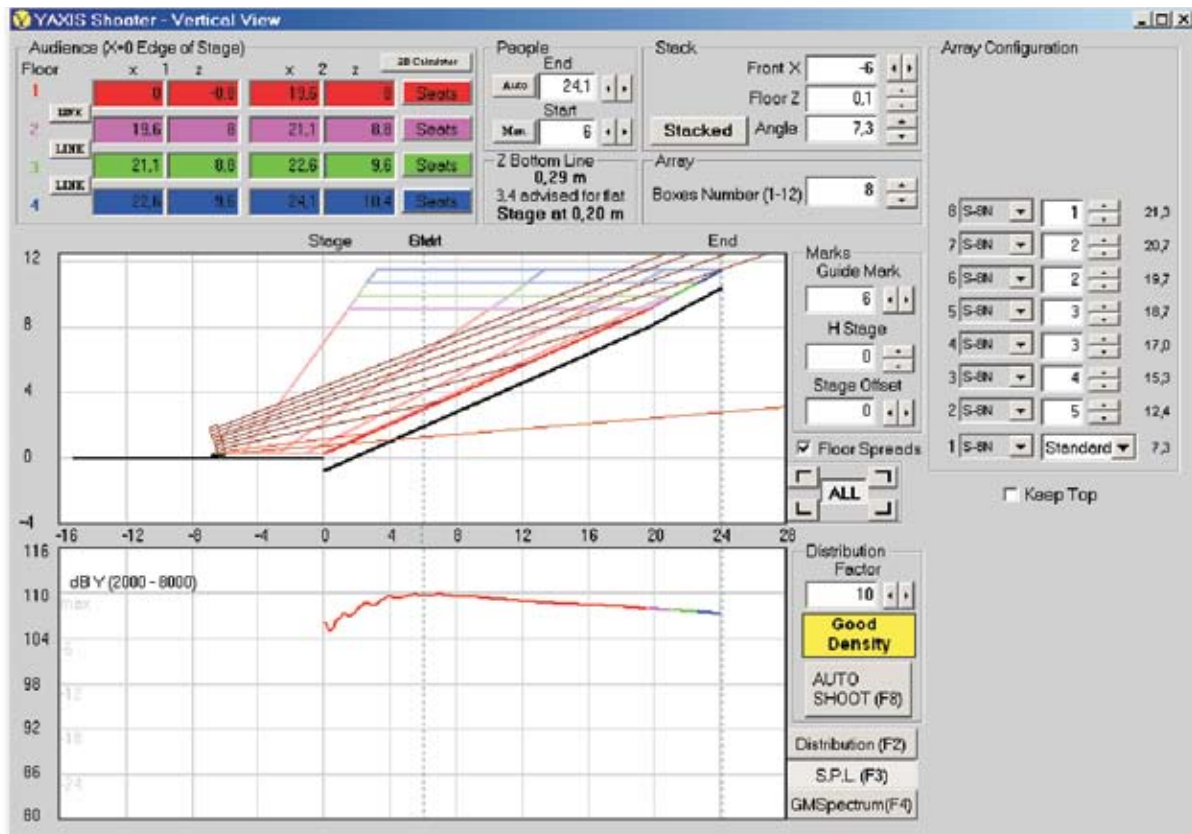
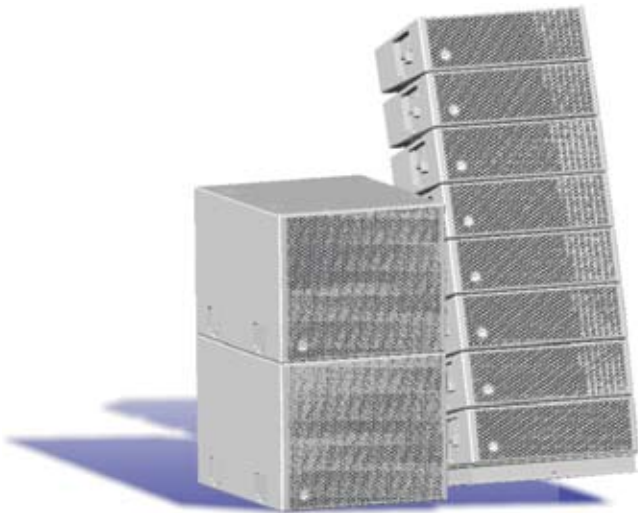

5.0 SpekTrix Configuration Examples

Stacking Configuration - Example 4

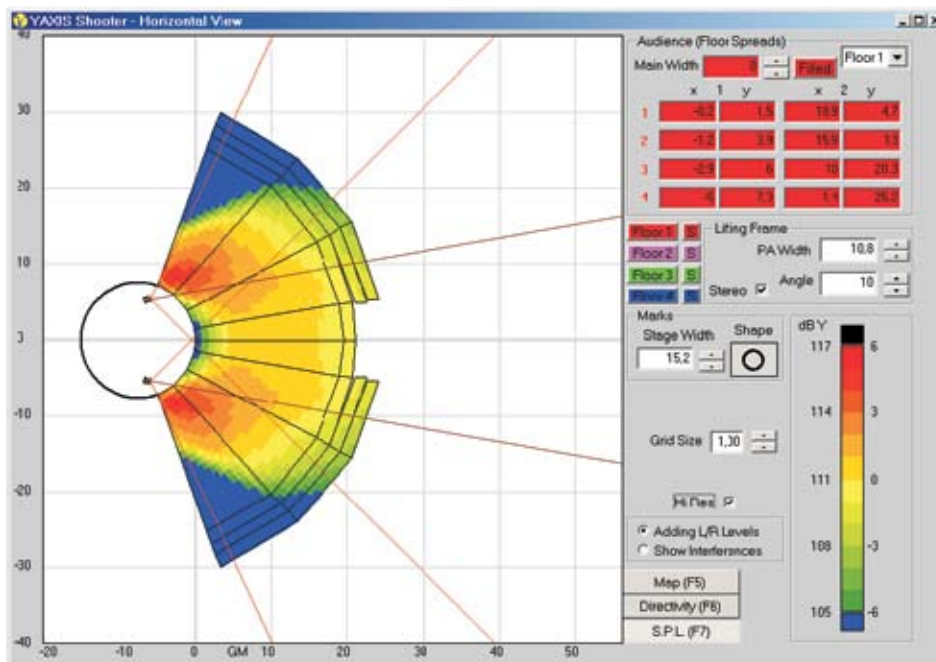
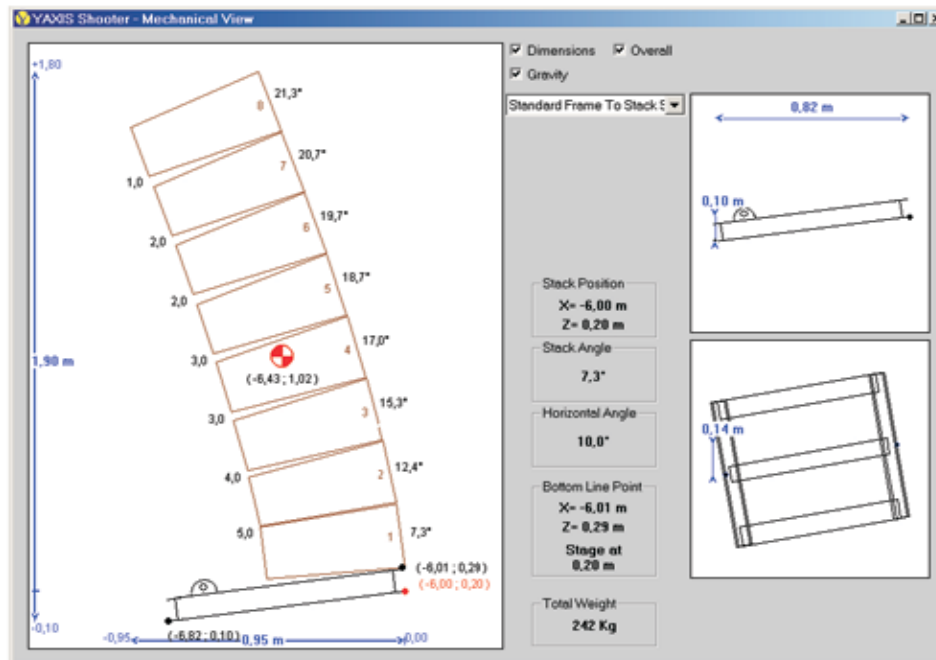



5.0 SpekTrix Configuration Examples



Flown Configuration - Example 5

Configuration: 6 flown Spek-Trix and 2 - 3 SpekTrix Subs.

Application: Coverage for a level area, 35 to 45 meters deep with very high SPL.

Note: Optional small loudspeakers for front fills.

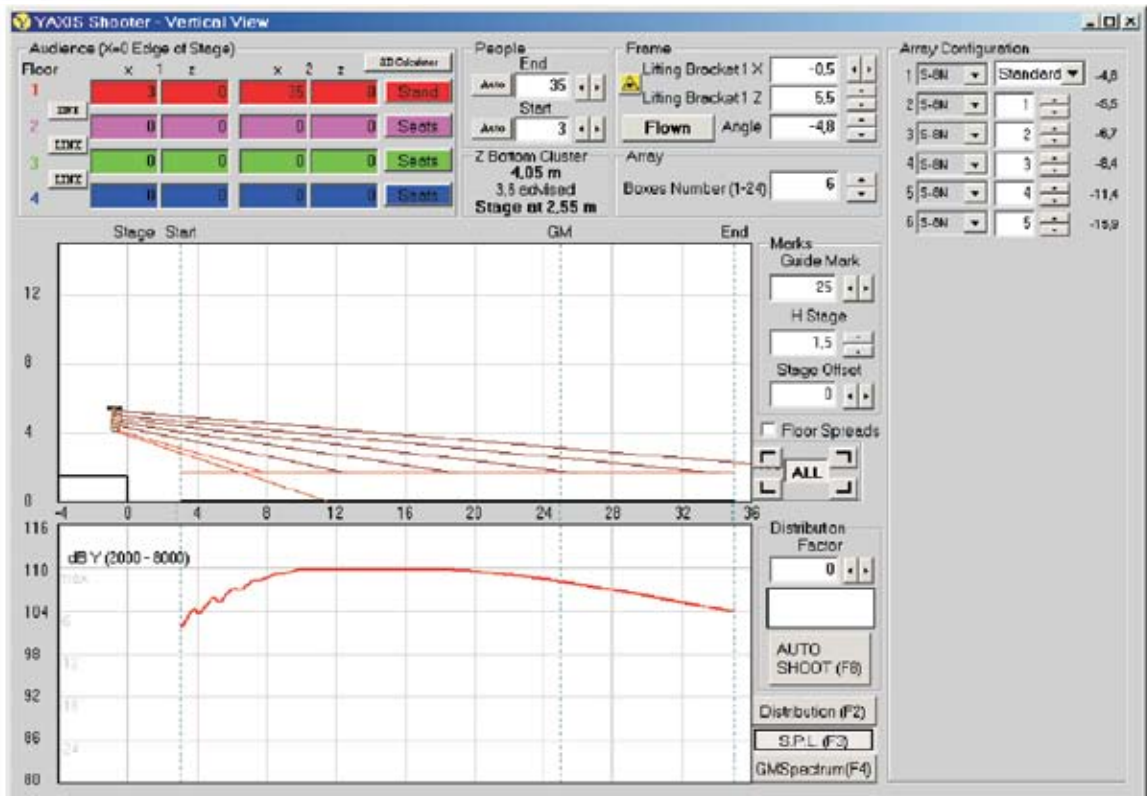

5.0 SpekTrix Configuration Examples

Flown Configuration - Example 5

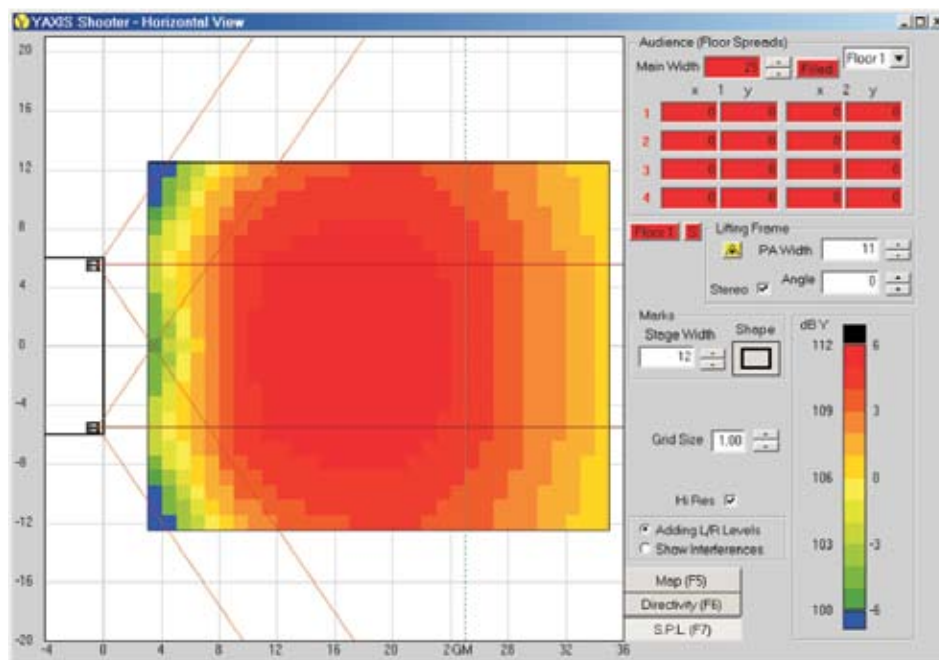
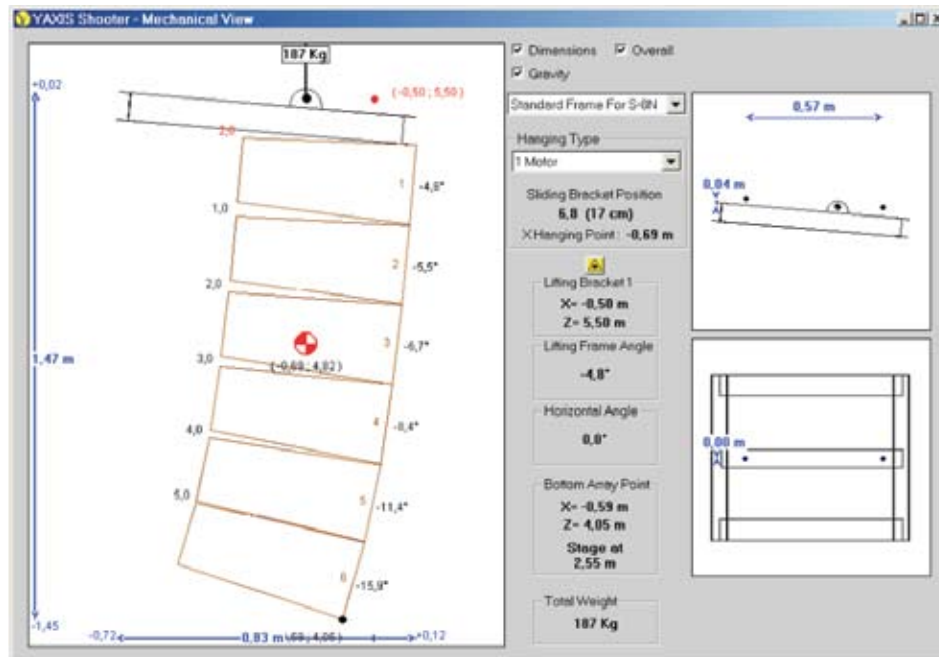



5.0 SpekTrix Configuration Examples



Flown Configuration - Example 6

Configuration: 8 SpekTrix and 2 - 4 SpekTrix Subs.

Application: Coverage for a level area, 50 meters deep with very high SPL.

Note: Optional small loudspeakers for front fills.

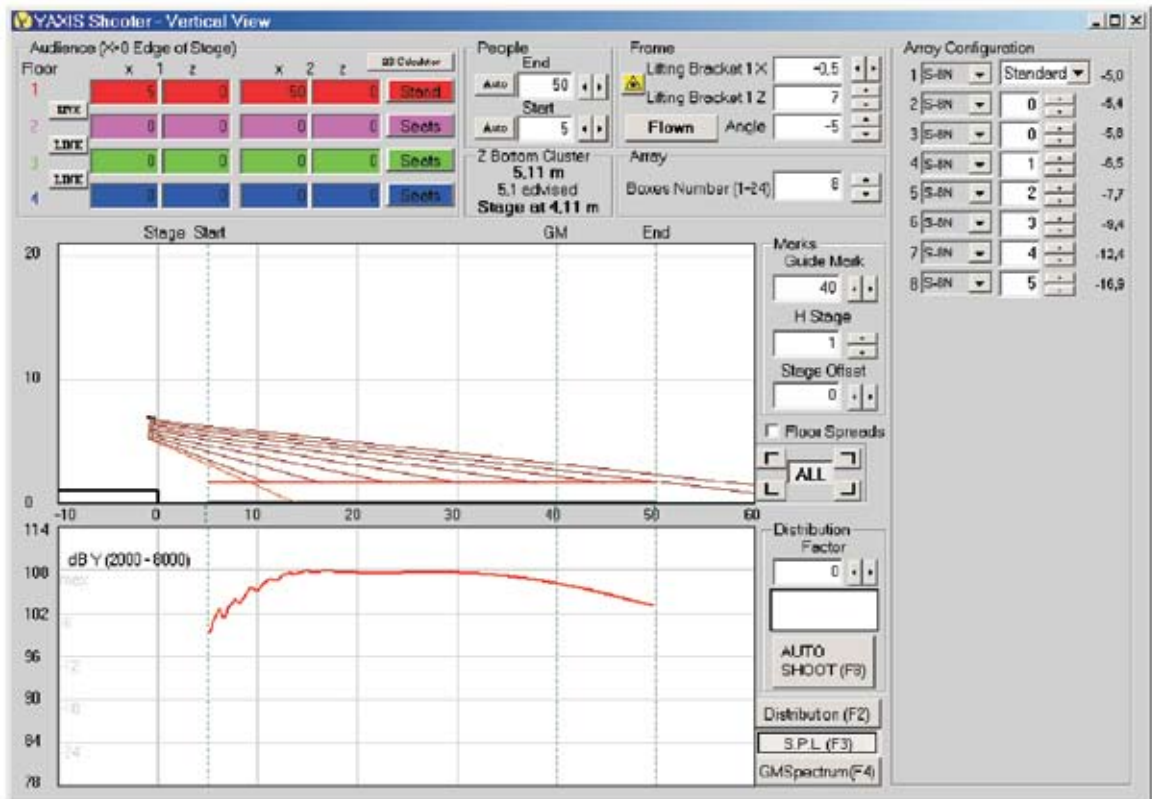

5.0 SpekTrix Configuration Examples

Flown Configuration - Example 6

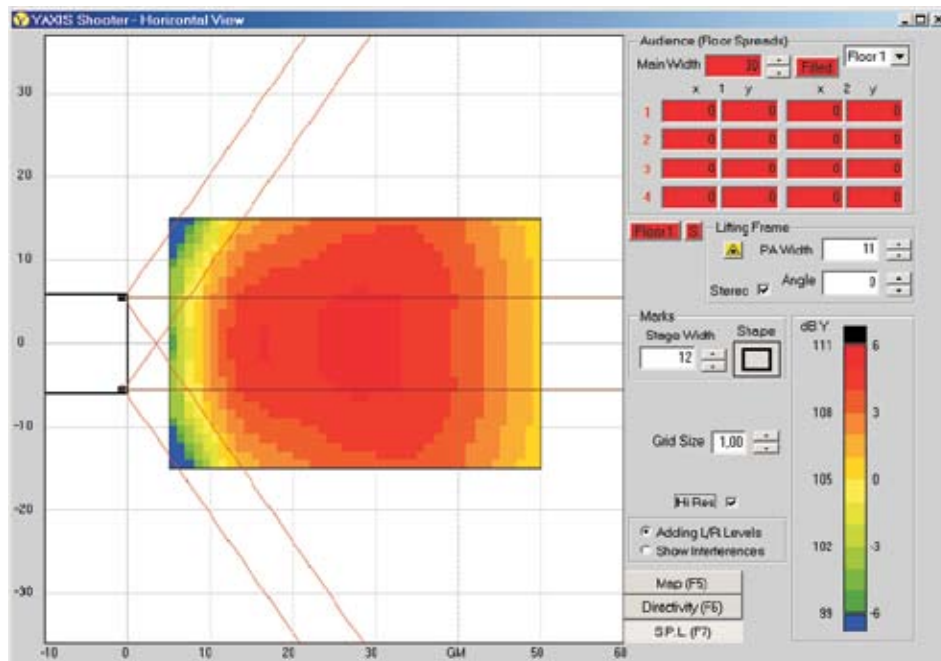
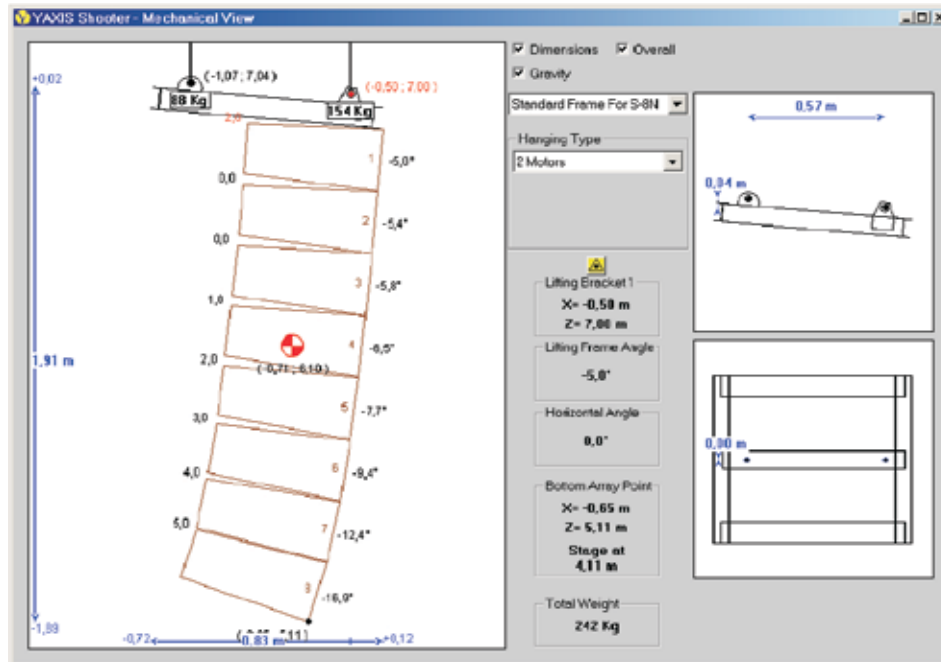



5.0 SpekTrix Configuration Examples



Flown Configuration - Example 7

Configuration: 12 flown SpekTrix and 3 - 6 SpekTrix Subs.

Application: Open air music festival. Coverage for a level area, 60 to 80 meters deep with very high SPL.

Note: Optional small loudspeakers for front fills.

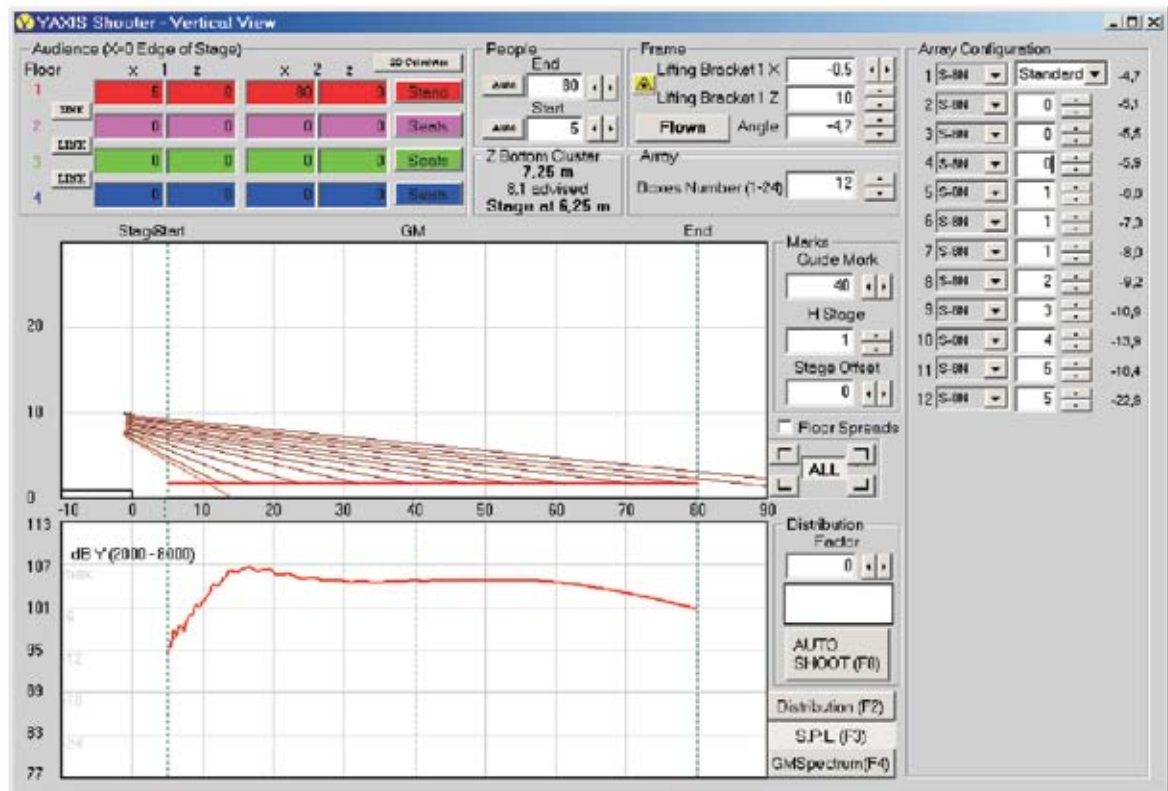

5.0 SpekTrix Configuration Examples

Flown Configuration - Example 7

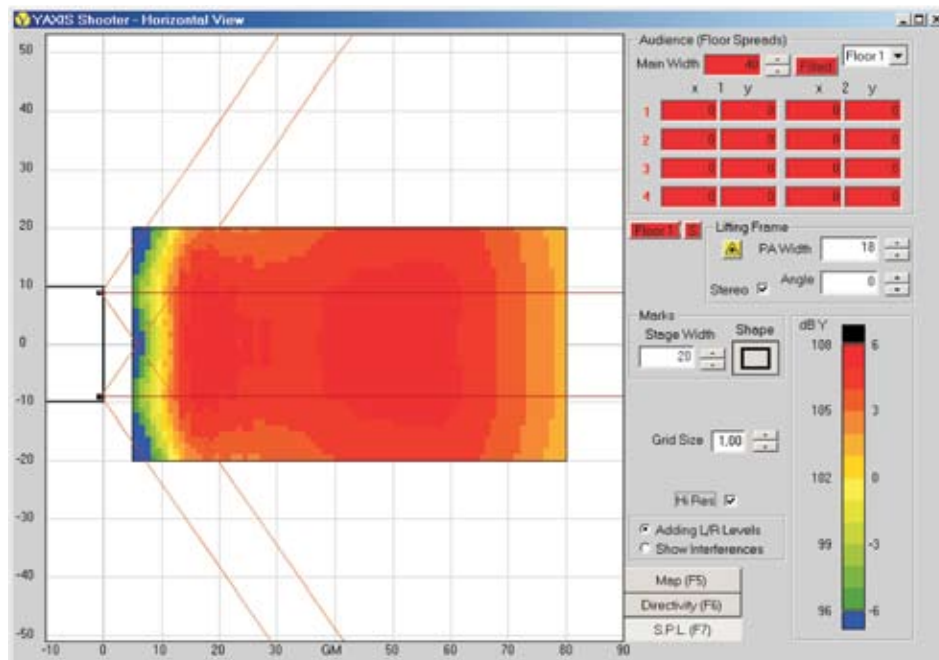
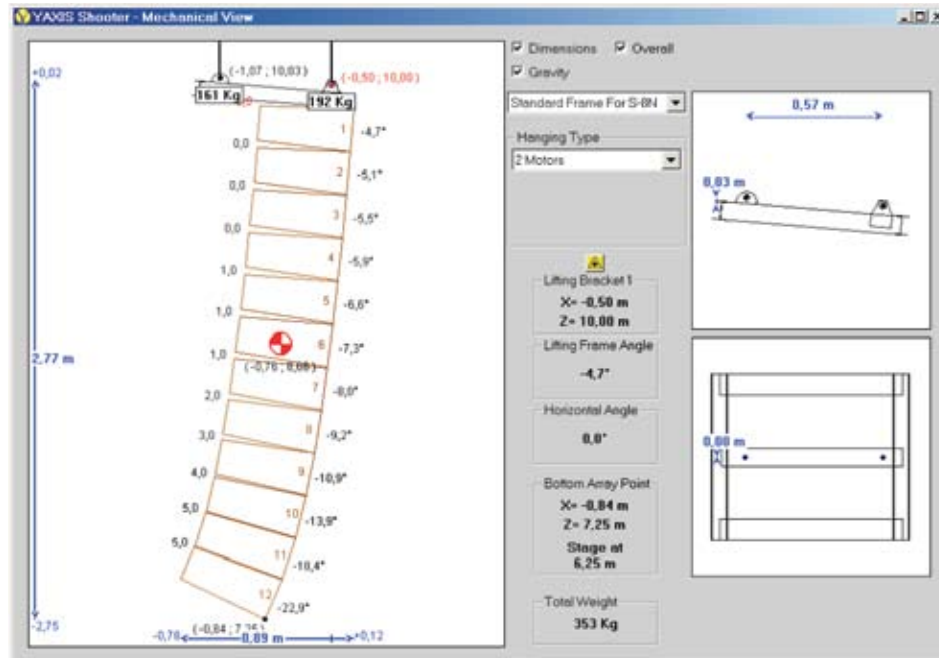



5.0 SpekTrix Configuration Examples

Stacking Configuration - Example 8

Configuration: 2 SpekTrix Subs in "omni" mode.

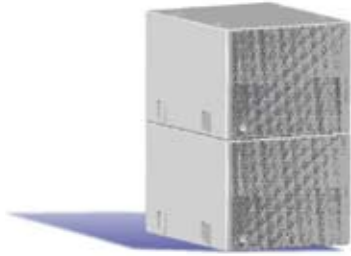

Stacking Configuration - Example 9

Configuration: 2 SpekTrix Subs in "cardioid" mode.

Note: The front and back cabinets are amplified separately and must be processed with the Adamson DX6000 or XTA 4-Series Controllers.

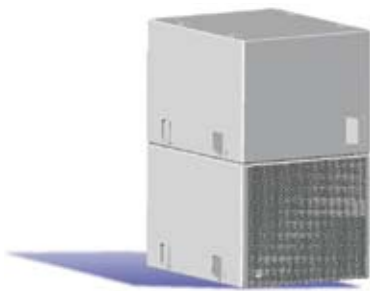

5.0 SpekTrix Configuration Examples

Stacking Configuration - Example 10

Configuration: 3 SpekTrix Subs in "omni" mode.

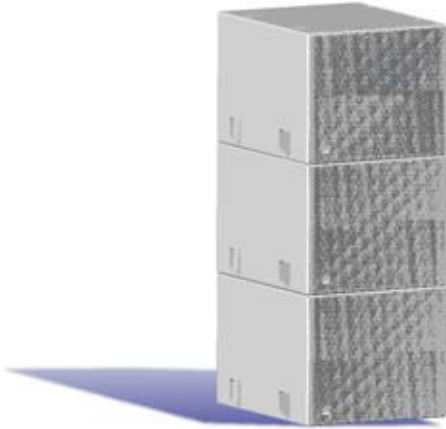

Stacking Configuration - Example 11

Configuration: 3 SpekTrix Subs in "cardioid" mode.

Note: The front and back cabinets are amplified separately and must be processed with the Adamson DX6000 or XTA 4-Series Controllers.

Application: This configuration provides a 2:1 ratio and gives maximum headroom.

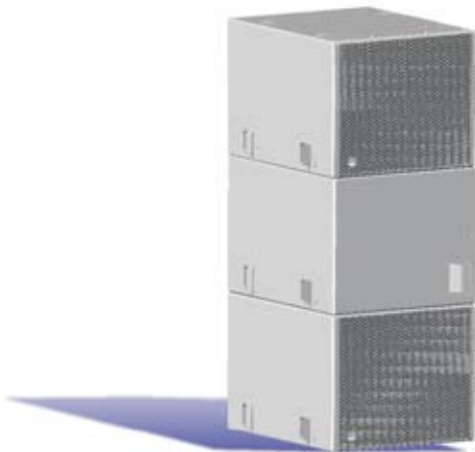



5.0 SpekTrix Configuration Examples

Flown Configuration - Example 12

Configuration: 6 flown SpekTrix Subs in "omni" mode.



Flown Configuration - Example 13

Configuration: 6 flown Spek-Trix Subs in "cardioid" mode.

Note: The front and back cabinets are amplified separately and must be processed with the Adamson DX6000 or XTA 4-Series controllers.

Application: This configuration provides a 2:1 ratio and gives maximum headroom.

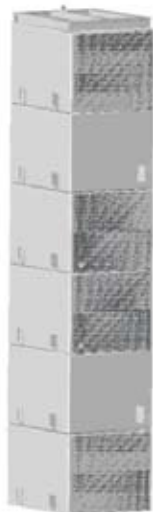

5.0 SpekTrix Configuration Examples

Flow Configuration - Example 14

Configuration: 2 SpekTrix Subs flown with 10 SpekTrix.

Application: Theater with multiple balconies.



Flow Configuration - Example 15

Configuration: A SpekTrix Sub array flown beside a large size SpekTrix array.

Application: This configuration is recommended for optimal phase coupling between SpekTrix Subs and SpekTrix.

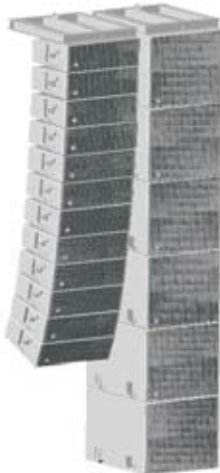



5.0 SpekTrix Configuration Examples

Combination of Flown & Stacked Configuration - Example 16

Configuration: the SpekTrix Sub can be also stacked when flying possibilities are limited.

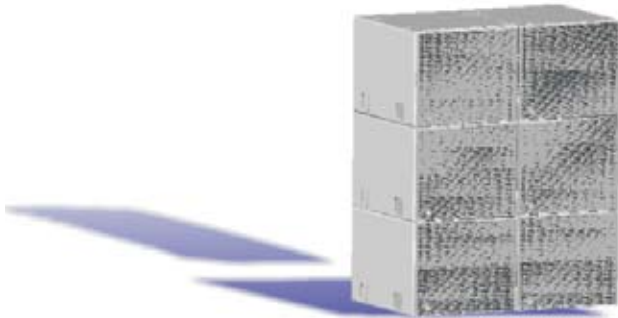

5.0 SpekTrix Configuration Examples

Flown Configuration - Example 17

Configuration: A SpekTrix array beside a SpekTrix Sub array flown in "cardioid" configuration.

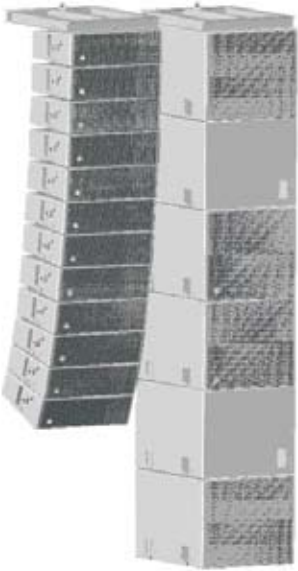

Front View

Back View

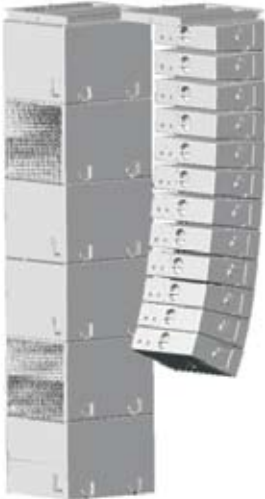



5.0 SpekTrix Configuration Examples

Flown Configuration - Example 18

Configuration: 2 SpekTrix W's hung under 4 SpekTrix.

Application: Downfill.

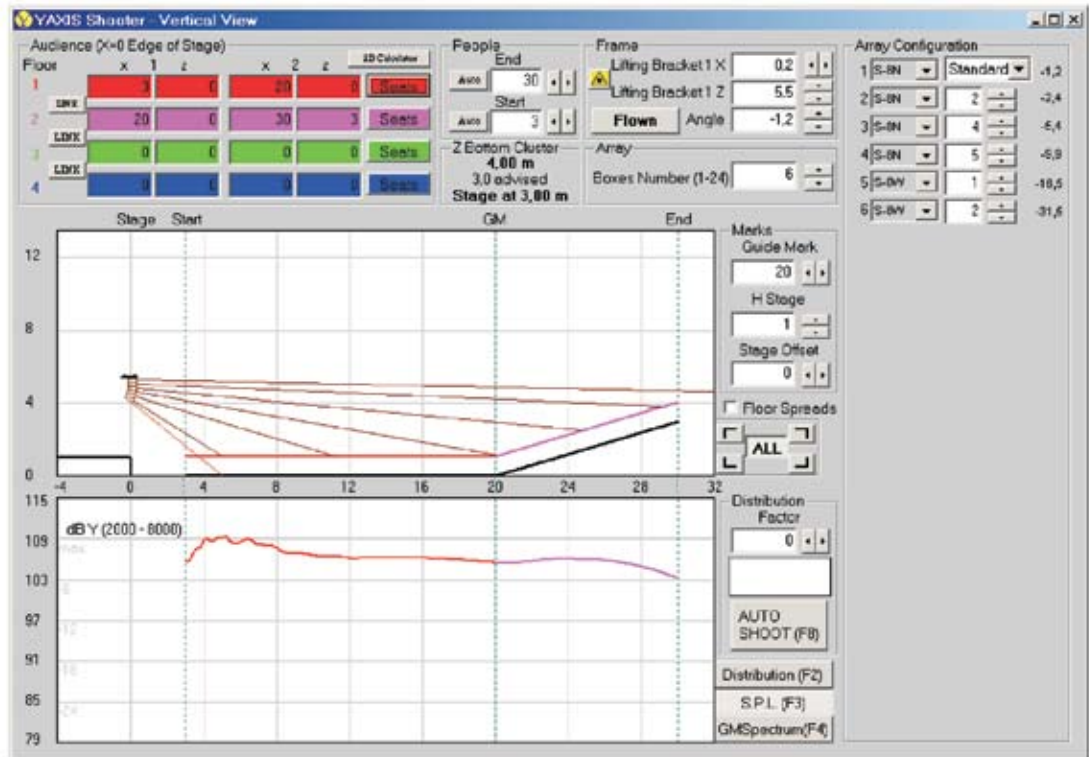
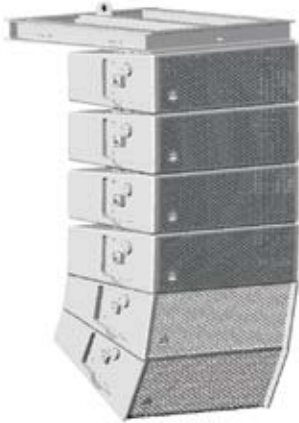

5.0 SpekTrix Configuration Examples

Flown Configuration - Example 18

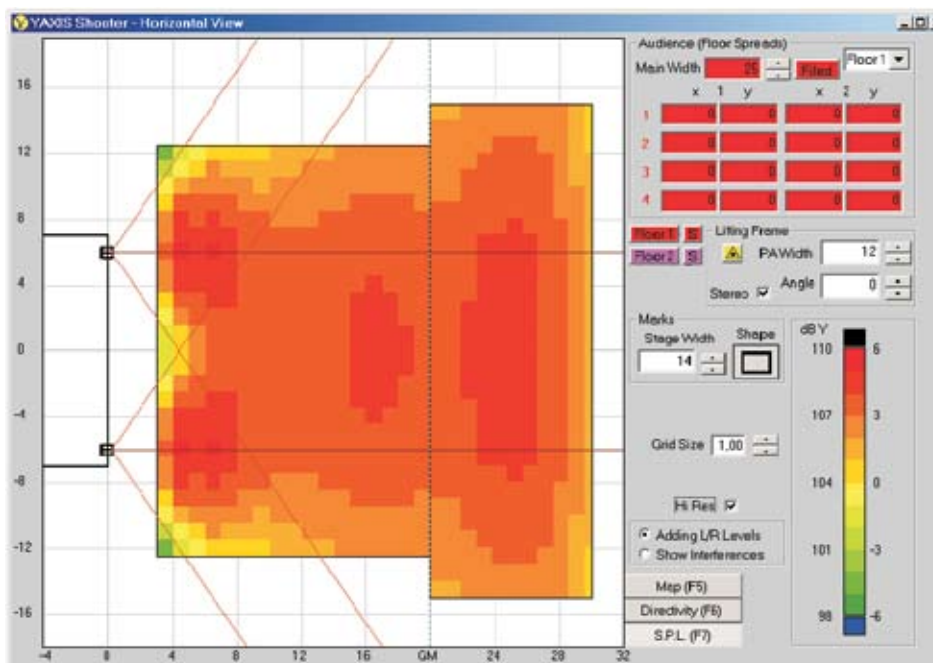
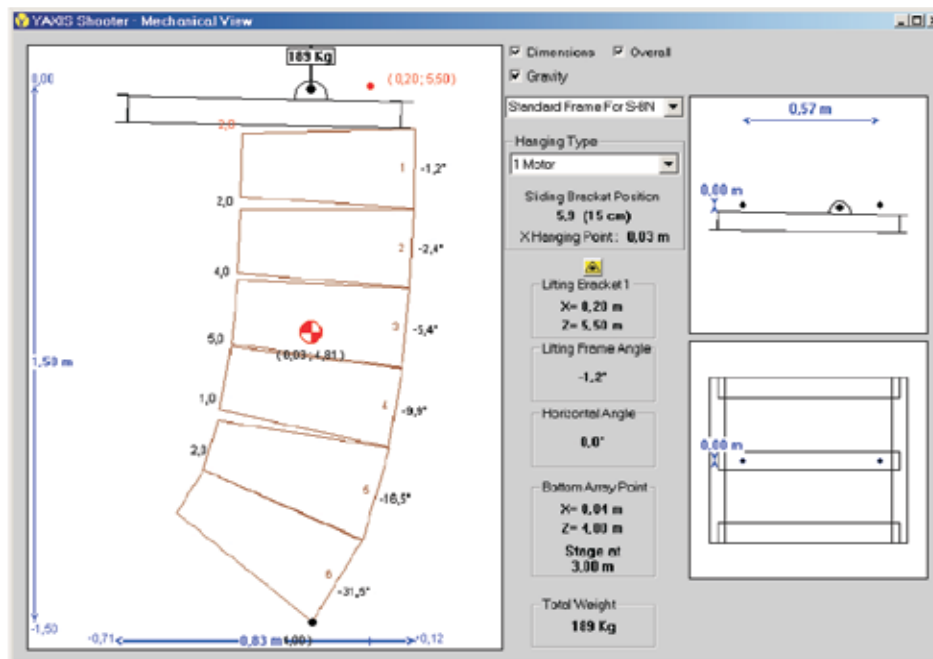



5.0 SpekTrix Configuration Examples

Flown Configuration - Example 19

Configuration: 4 flown SpekTrix W's.

Application: Provides wide vertical coverage, ideal for theaters with multiple balconies.

Note: 4 Boxes is an acceptable configuration only as a ground stack (see examples 1 & 2 & 3) or as a flown front fill shown here.

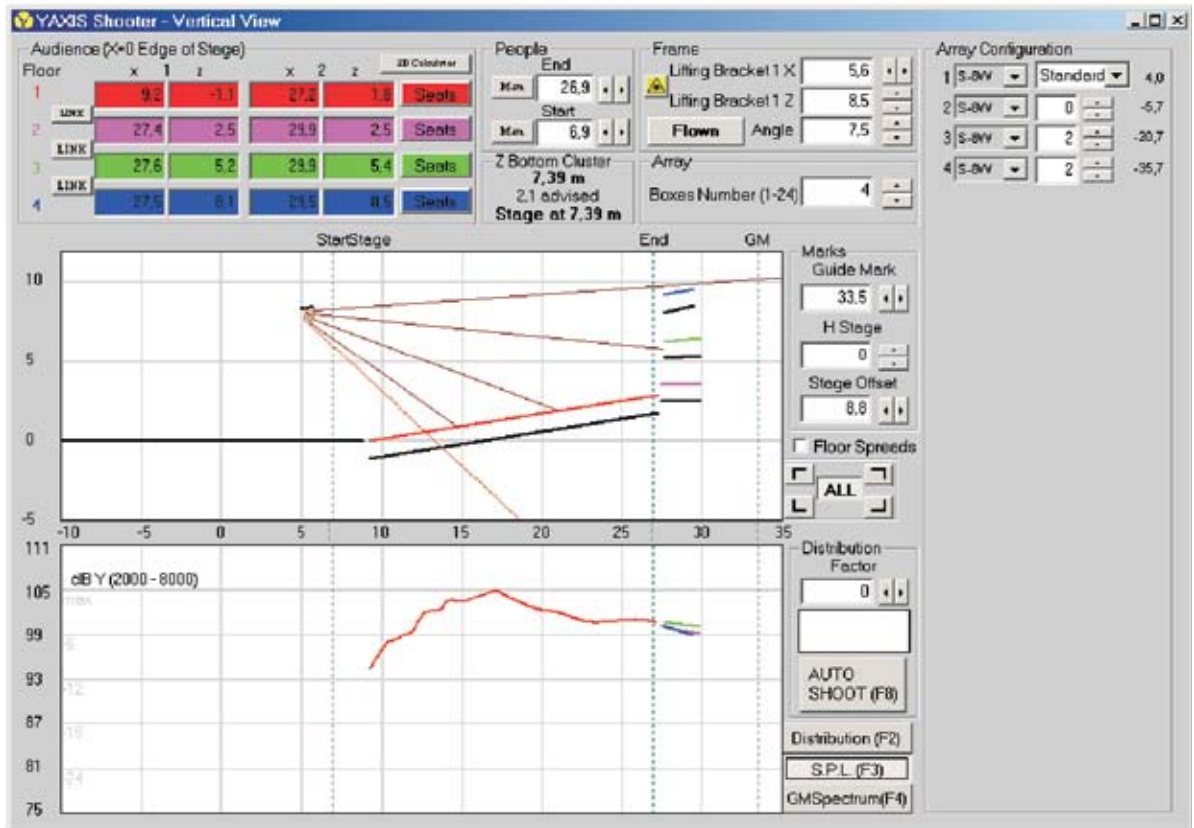

5.0 SpekTrix Configuration Examples

Flown Configuration - Example 19

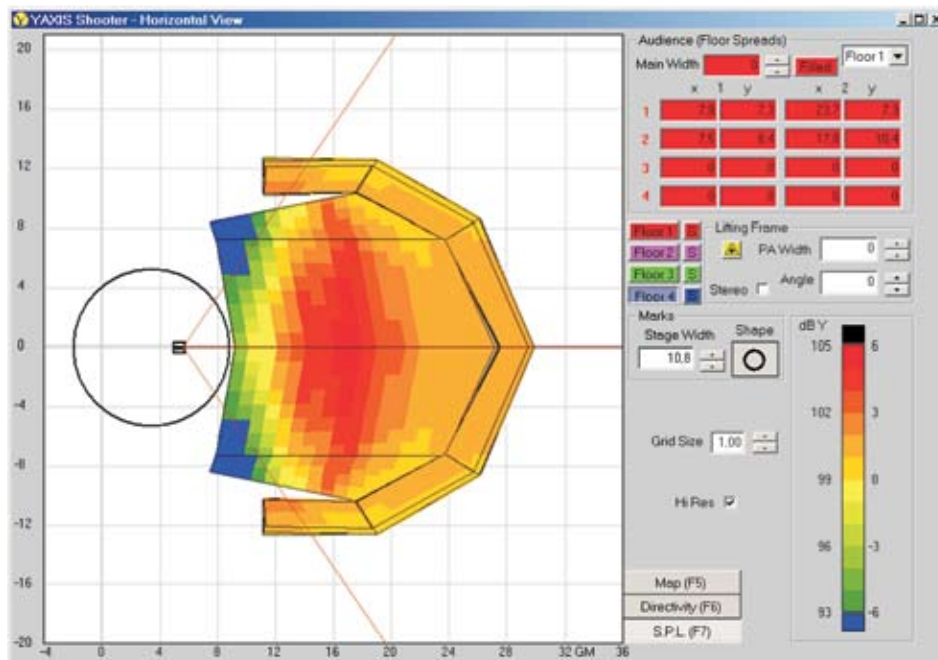
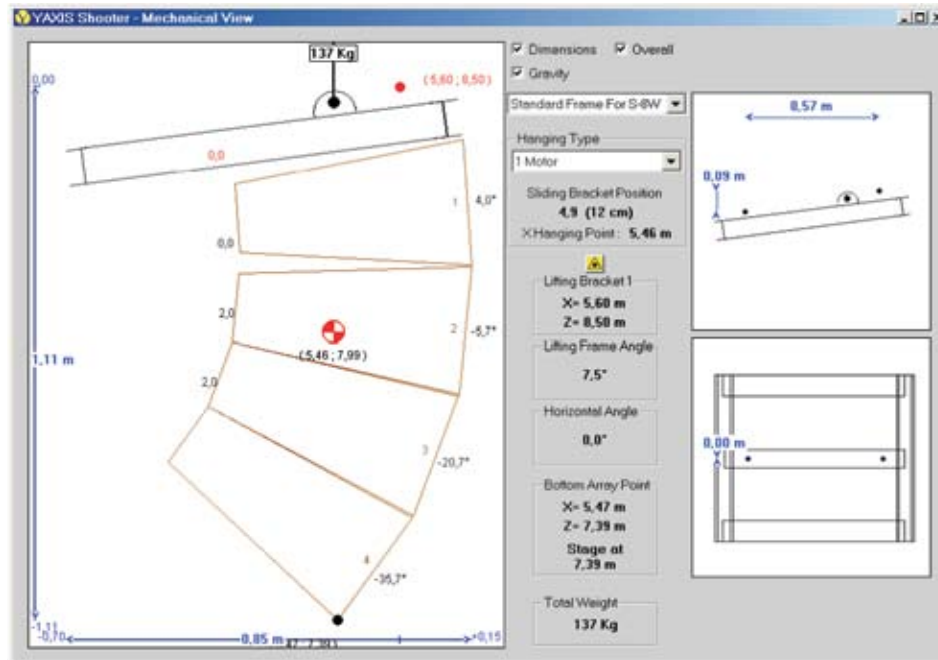



Adamson Systems Engineering

1401 Scugog Line 6,
Port Perry Ontario, Canada, L9L 1B2

T: [905] 982 0520

F: [905] 982 0609

www.adamsonproaudio.com sales@adamsonproaudio.com